

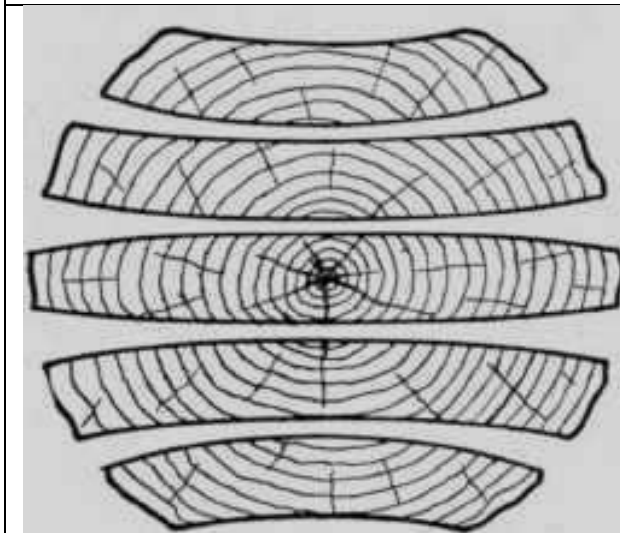

# CODE OF PRACTICE FOR WOOD PROCESSING FACILITIES (SAWMILLS & LUMBERYARDS)

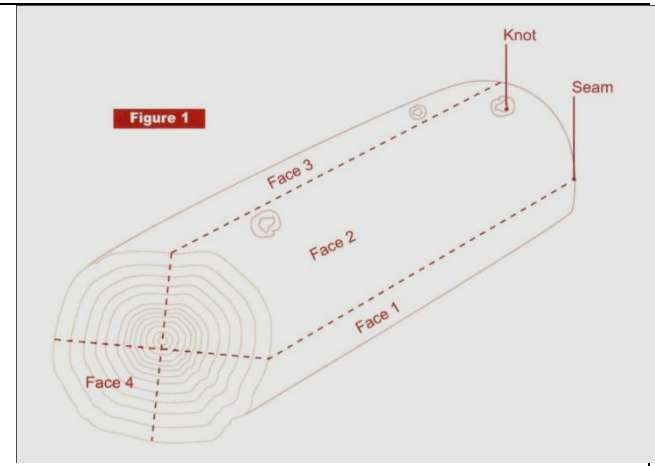

Version 2

January 2012

Guyana Forestry Commission

# Table of Contents

FOREWORD .....	7
1.0 INTRODUCTION .....	8
1.1 Wood Processing.....	8
1.2 Development of the Code .....	9
1.3 Scope of the Code .....	9
1.4 Objectives of the Code.....	10
1.5 Implementation of the Code.....	10
2.0 PRE-SAWMILLING RECOMMENDATIONS.....	11
2.1 Market Requirements .....	11
2.1.1 General.....	11
2.1.2 Product Type .....	11
2.1.3 Product Mix Selection.....	12
2.2 Logs - Raw Material input .....	13
2.2.1 Cutting/Forest Management .....	13
2.2.2 Transportation of logs.....	14
3.0 SAWMILLING REQUIREMENTS .....	15
3.1 Legal requirements .....	15
3.2 GFC Requirements: .....	15
3.3 Design of Sawmill .....	15
3.3.1 Sawmill Design, Type and Layout.....	15
3.3.2 Sawmill System .....	16
3.3.3 Headrig / Breakdown Saw Requirements .....	17
3.3.4 Gang Rip Saws .....	18
3.3.5 Board Edger.....	19
3.3.6 Trim or Cross-cut Station .....	19
3.3.7 Accessories to Enhance Productivity and Reduce Costs.....	20
3.4 Log Yard Operations.....	21
3.4.1 Storage of Logs.....	21
3.4.2 Preparation of Logs .....	21
3.4.3 Grading/Identify Open Face.....	22

3.4.4 Log Loading and Orientation.....	24
3.5 Sawmilling Operations .....	25
3.5.1 General.....	25
3.5.2 Primary Log Breakdown/Headrig/Resaw.....	25
3.6 Sawing Patterns .....	26
3.6.1 Live-Sawing .....	26
3.6.2 Cant Sawing.....	27
3.6.3 Quarter Sawing .....	28
3.6.4 Grade Sawing .....	29
3.6.5 Back Sawing.....	33
3.7 Edger Operation.....	34
3.8 Trim Saw/Cross-cut Saw Operation .....	35
3.9 Rough Planing .....	35
3.10 Production Tolerances - Specifications for Rough Sawn Lumber .....	35
3.11 Chainsaw Milling .....	37
4.0 QUALITY ASSURANCE ACTIVITIES.....	38
4.1 Documentation/Record Keeping .....	38
4.2 Training and Competency of Personnel.....	38
4.3 Maintenance of Equipment. ....	39
4.3.1 Saw-doctoring (filing).....	39
4.4 Calibration of Measuring Instruments and Equipment .....	41
5.0 OTHER NON-SAWMILLING ACTIVITIES THAT MUST BE ADHERED TO IN A PROCESSING OPERATION: 42	
5.1 General.....	42
5.2 Stacking/Racking .....	43
5.3 Methods for Drying Lumber.....	44
5.3.1 Air-dry Lumber .....	44
5.3.2 Kiln-dry Lumber.....	45
5.3.3 Solar Drying.....	45
5.4 Grading of Lumber .....	46
5.5 Treating and Preserving Lumber - Preventative Treatment .....	46
5.6 Dressing Lumber/Finishing Planer - Specifications for Dressed Lumber .....	46

6.0 SOCIAL REQUIREMENTS .....	48
6.1 National Insurance Scheme .....	48
6.2 Labour Acts .....	48
7.0 HEALTH AND SAFETY REQUIREMENTS.....	49
7.1 General.....	49
7.2 Personal Protective Equipment (PPE) .....	49
7.3 Safeguards on Equipment .....	50
7.4 Appropriate Signs Displayed .....	50
7.5 Training and Competency of Personnel.....	51
7.6 Fire Protection .....	51
7.7 Community and Work Place Relations.....	52
8.0 ENVIRONMENTAL REQUIREMENTS .....	54
8.1 General.....	54
8.2 Solid Waste Management.....	54
8.2.1 Conversion Efficiency .....	56
8.2.2 Recycling and Disposal .....	56
8.3 Emissions to Air.....	56
8.4 Waste-water/Effluent Discharge .....	57
8.5 Noise/Vibration.....	57
8.6 Toxic and Hazardous Chemicals.....	59
8.7 Visual Management .....	59
8.8 Site Selection.....	59
9.0 GLOSSARY OF TERMS and ACRONYMS. ....	60
10.0 LIST OF REFERENCES .....	64

## **List of Tables**

Table 1: Specified sawing size (thickness) for rough sawn lumber .....	36
Table 2: Specified oversize (maximum) for width size for rough sawn lumber .....	36
Table 3: Specified Thicknesses and Tolerances for Rough Sawn and Dressed Lumber .....	46

## List of Figures

Figure 1: Typical production chain - Timber processing .....	12
Figure 2: Logs protected with S- hook and sealed, and untreated log drying out and splitting at end .....	14
Figure 3: Simple sawmilling process flow .....	16
Figure 4: Showing Bandsaw Headrig.....	17
Figure 5: Showing multiple blade rip saw .....	18
Figure 6: Showing Board Edgers.....	19
Figure 7: Showing Trim or Cross-cut saw .....	20
Figure 8: Cutting large logs for processing operations .....	22
Figure 9: Grading of logs to identify faces. ....	24
Figure 10: Steps in conducting live-sawing.....	27
Figure 11: Steps in conducting cant-sawing .....	28
Figure 12: Steps in producing quartersawn lumber .....	29
Figure 13: Steps in conducting grade sawing .....	30
Figure 14: Grade sawing based on opening face to remove defects on outside.....	31
Figure 15: Grade sawing based on cutting in line with defective centre .....	31
Figure 16: Use of taper to raise logs and cut in line when opening best face.....	32
Figure 17: Non use of taper to cut into worse face opening .....	33
Figure 18: Steps in back sawing logs to cut around a defective heart .....	34
Figure 19: Optimizing value in lumber by removing defects.....	34
Figure 20: Use of Boardmill with chainsaw for processing logs .....	37
Figure 21: Storage of blades .....	40
Figure 22: Storage of knives .....	40
Figure 23: Measuring tools for wood processing operations .....	41
Figure 24: Proper and improper storage of lumber .....	42
Figure 25: Stacking and Stickers of lumber .....	43
Figure 26: Air drying lumber in open yard and under a shed.....	45
Figure 27: Waste generated from forestry value chain.....	55

<b><u>ACRONYMS</u></b>	
<b>EIA</b>	Environmental Impact Assessment
<b>EPA</b>	Environmental Protection Agency
<b>GDP</b>	Gross Domestic Product
<b>GFC</b>	Guyana Forestry Commission
<b>ITTO</b>	International Tropical Timber Organisation
<b>LVL</b>	Laminated Veneer Lumber
<b>MC</b>	Moisture content
<b>MDF</b>	Medium Density Fiberboard
<b>MSDS</b>	Material Safety Data Sheet
<b>OSH</b>	Occupational Safety and Health
<b>PPE</b>	Personnel Protective Equipment
<b>USFS</b>	United States Forest Service

## **FOREWORD**

This Code expresses the Government of Guyana and the Forestry Sector's vision for wood processing facilities in Guyana. It provides guidelines for best practices that will allow maximum returns from sawmilling and lumberyard operations, ensure that continuing economic returns can be obtained over the long term, and fostering overall sustainable development of Guyana's forest resources.

This Code takes into account the various Acts and Legislations that are directly related to the wood processing industry and was developed in 2011 as a collaborative effort of the Government of Guyana and the forest sector, with support from the International Tropical Timber Organisation (ITTO) and the United States Forest Service (USFS)

It is designed to balance commercial and environmental considerations with social values through developing and implementing an integrated management system that will improve efficiency and address environmental, quality, and occupational safety and health concerns.

Wood products companies require an efficient recovery of lumber from logs to remain profitable and competitive. For this to happen, the company needs to obtain the best yield in lumber from its operations based on its raw material, product, processing equipment, processing environment, and knowledge and skill of the employees. This document discusses several key principles that can help manufacturers contemplate and solve yield and production problems.

**It is the intention that all sawmilling and lumberyard operations will show progress towards compliance to this document which will be legally binding for all new operations, whilst selected elements will be made mandatory for existing licensees with full implementation within stated time frames. In the first year, utilizing a phased approach GFC will identify and monitor specific requirements as being mandatory and from the second year, all MUST clauses will be mandatory and monitored.**

The implementation of this Code will also be facilitated through a capacity-building strategic plan and training activities, and the development of other guidance documents which will provide more detailed information on the subject matter covered in the Code of Practice.

This Code of Practice for Wood Processing Facilities (Sawmills and Lumberyards), which will supplement the Code of Practice for Timber Harvesting, is considered as the 2<sup>nd</sup> step in the process of facilitating the maximization of returns from the sustainable utilization of Guyana's forest resources to increase benefits for all Guyanese. It is expected that the practices specified in this document will result in products that are of quality and better suited for the immediate market and for tertiary processing.

The information contained in this Code is intended to provide required guidance and requirements for recorded best practices for the sector. The objective is to encourage the adoption of minimum standards that will act as the driving force to encourage improvement in the current practices of the industry and facilitate maximum benefits for Guyana in the utilization of its natural resources.

This Code is divided into 10 sections, of which 7 sections (2 to 8) discusses the best practices for the various stages of primary processing and regulatory compliances, to promote the profitable operation of sawmill and lumber yards.

## **1.0 INTRODUCTION**

### **1.1 Wood Processing.**

Sawmilling, which is usually considered as a simple manufacturing process, (i.e. cutting down a tree, sawing, and generating lumber), is in fact a highly technical and sophisticated industry that must be constantly monitored so that businesses can respond to change effectively.

The major factors that influences sawmilling operations include securing log supplies; properly designed and engineered production facilities; environmental, regulatory and power supply issues; constant training for professionals in management, operations, maintenance, sales, marketing, logistics; and analysis of raw material resources and product lines, to maintain long term profitability.

From analysis of data provided by sawmills to GFC and recovery rate studies conducted prior to the development of this Code (April – August. 2010), the sawmilling sector in Guyana demonstrates recovery rates from processing of logs (chainsaw and static mill sawn lumber) ranging from 25-50 percent based on the species of log and the technology/equipment used. Of the processed lumber, only about 30-40 percent of the output is of export quality.

This low conversion efficiency results in the generation of a large amount of waste which affects the profitability of the business, the economy, and causes environmental problems, hence the need for the wood processing industry in Guyana to implement an efficient set of standards and practices to guide the operations in sawmills and lumberyards.

At the same time, changes in the marketplace have created the demand for different products of superior quality as revealed by an international review conducted by the GFC which shows that Caribbean demand, as well as demand expressed to the Marketing Council and GFC, can be expanded to a range of products in addition to some of the products that are currently supplied by Guyana such as marine timber and construction materials.

The economic returns derived from wood processing are significant compared to that of primary production of logs, for as the value chain extends, there is a significant increase in returns and contribution to the economy. Over the past 4 years, wood processing manufacturers have been able to diversify into new products such as: veneer, niche-market furniture, household components - doors, and kiln-dried lumber, and there is potential for further expansion.

For the sector to realize its potential there is the need for extensive training of personnel at all levels and in all aspects of wood processing operations, to enable the production of quality products required by the markets; and a shift to newer technology within sawmilling operations to increase the conversion efficiency/recovery from round logs. However, whilst advanced technology, computerization etc. are good; they must be directly linked to availability and development of support services and quality of operating environment.

The forest operations aspect has been dealt with in the Code of Practice for Timber Harvesting and other documents which are being updated regularly to promote sustainable forest management. The next step is to upgrade wood processing operations. This proposed Code will deal with sawmilling and lumberyard operation. Other value added operations will be addressed in future efforts and documents.



## 1.2 Development of the Code

This Code contains recommendations and requirements informed by best practices, which have been developed based on both domestic and foreign research, and practical experiences. Previous attempts were made to document a Code for this sector; however the documents were confined to addressing concerns relating to environment and occupational safety and health.

As a result of Government's policies, feedback from stakeholders of the sector and the successes that were achieved through the implementation of the Code of Practice for Timber Harvesting, a decision was taken that similar documents should be developed for the wood processing sector that will be used to regulate, improve operations and increase the efficiency of wood processing operations.

The process of developing, reviewing and approving this Code was detailed as an output of a project between the Government of Guyana and ITTO. The process involved: reviewing of policy and legislative documents, gathering baseline data, development of a draft document, consultation with stakeholders to gather comments and feedback information, local and international review, incorporating comments, finalizing draft document and approval of finalized Code.

During the development process of this Code, analysis were conducted on the data provided by sawmills to the GFC to arrive at the present status of the sector. This was followed by research and analysis of data acquired from conducting recovery studies utilizing different technologies and practices, to identify the "best practices" that will realize the maximum value from processing logs. The identified practices were then discussed with local stakeholders and visits were made to observe the practices being implemented in the USA and Suriname.

## 1.3 Scope of the Code

This Code applies to all sawmills engaged in the stockpiling and sawing of round logs of all timber species or sawing of cants, squares and other forms of sawn forest timber products, into sawn lumber. It applies to all processes conducted within such sawmills and sawmill yards, including handling round logs, sawing round logs into sawn timber, handling sawn timber, air drying of sawn timber, as well as the management of sawmill waste within the boundaries of a sawmill yard.

This Code of Practice for Sawmilling and Lumberyards does not cover value-added operations such as: furniture manufacturing, production of mouldings, etc. Sawmilling and lumberyard operations should recognize and consider all or relevant aspects of this Code in the day to day management and operation of their facilities.

There are two different types of statements in the code: '**must**' (in some cases phrased as an imperative) and '**should**' statements. The "**must**" statements are to be applied in a practical manner to sawmilling operations. The '**should**' statements show the desirable practice for improving efficiency competitiveness and should be interpreted taking account of local conditions and management decision. All operations are required to comply with the statements associated with '**must**' in this Code of Practice.

## 1.4 Objectives of the Code

The Government of Guyana through the National Forest Policy 2011 and the National Forest Plan 2011 specifies the utilization of logs in downstream value added processing to maximize national benefits from the use of forest resources. One of the steps in the realization of this goal is the development of a Code of Practice for Wood Processing.

It is expected that with the implementation of this Code of Practice, the following results will be achieved:

- Maximize the recovery of value from logs for increased competitiveness and profitability
- Reduce/minimize waste
- Reduce the environmental impacts of primary wood processing.
- Facilitate sustainable and economical utilization of forest resources
- Produce quality, high priced products for local and export markets
- Provide sawmill and lumberyard owners/operators with a set of guidelines and standards for improved management practices and production of quality products for their customers
- Improve the health and safety of sawmill and lumberyard employees
- Provide a framework for effective control of sawmilling and lumberyard operations based on rational guidelines and benchmarks
- Improve the relationship between the surrounding communities and business entities
- Enhance global market acceptance of Guyana's forest product

It is expected that with the implementation of the best practices being proposed in this Code, sawmilling operations will be able to make small gains at the various processes involved at the log yard, head rig, resaw, edger, trim saw and lumber yard to realize a more competitive and profitable operation.

It is also the expectation of the Government that greater recovery will result in having to cut fewer trees to attain the same output level and the improvement in processing operations will generate more value and employment, hence increasing the contribution of the forestry sector to GDP.

## 1.5 Implementation of the Code

This Code will have a phased mode of implementation, with full compliance expected for all '**must**' requirements within 2 years for existing operations and with immediate effect, for new operations.

The '**should**' requirements are recommended best practice to be implemented taking into consideration local conditions, target market and management decision for improved efficiency, competitiveness and profitability

The implementation of this Code will also be supported through the implementation of a Capacity-building Strategic Plan, and Policy Initiatives identified as necessary to support the implementation of the Code and Training Activities which are outputs of the ITTO project.

This Code **should** not be seen as a static document. It will need to be reviewed and updated as technical knowledge is augmented, new technologies are introduced, and operating standards improved so that environmentally sound, socially responsible, and economically prosperous sawmilling and lumberyard operations can be maintained.

## **2.0 PRE-SAWMILLING RECOMMENDATIONS.**

This section details some important recommendations that can have an impact in improving the efficiency and competitiveness, and the quality of the output/products of sawmilling operations.

### **2.1 Market Requirements**

#### **2.1.1 General**

Guyana's forest is characterized by dark, dense timber with slow growth rates, high species diversity, high stem defect rates and varying size of trees based on species and location, and therefore lower coupe rates per area of forest than most other tropical countries; hence the resource does not lend itself to the achievement of value through the economies of scale from processing large volumes. Essentially only niche market volumes are available. Therefore any investor/wood processor **should** focus on the following to match the resource to the markets:

- Focus on niche markets that are lower volume but more dynamic in nature – niche markets tend to be very quality conscious.
- Flexibility in production at all levels to be able to adapt equipment and techniques to meet the varying and dynamic demands inherent in niche markets.
- Target markets that they can effectively compete in – focus more on markets that have low volumes and high value so as to be able to compete with the big producers who find these small markets difficult to deal with.

All wood processing operations **must** conform to the requirement of the GFC for forest legality to establish that all lumber produced, **must** be derived from a legal source. These requirements prescribe the checks of forest operations and controls of supply chains from harvesting to export to confirm that the wood or lumber came from a legal source.

#### **2.1.2 Product Type**

Sawn Lumber is characterized based on the quality and quantity of “defects” in a piece as detailed in the Guyana Timber Grading Rules for Hardwoods, where grading is carried out according to the type of forest product intended for a certain use and permissible defects are defined for each grade.

Wood is utilized primarily in the construction sector and for tertiary processing into furniture, molding, decking, and other value added products.

The market requirements for wood in the construction industry is detailed in the Building Codes of the country where the wood is to be utilized and based on the density (wood species) and dimension for specific types of usage. The Guyana Building Code: Section 7 – Use of Guyanese Hardwood in Construction, provides guidance on the use of Guyanese timber species for construction purposes. It specifies requirements for quality, dimensions and engineering properties for various design considerations in the utilization of wood in the construction sector.

The requirements for wood to be used in secondary and tertiary processing are based on species and quantity of defects because of the emphasis on aesthetic value; requirement for dimension is without intent. This sector has the capacity to utilize random width and length of lumber because this gives them a range of optional sizes they can cut and flexibility in their production process in meeting production orders.

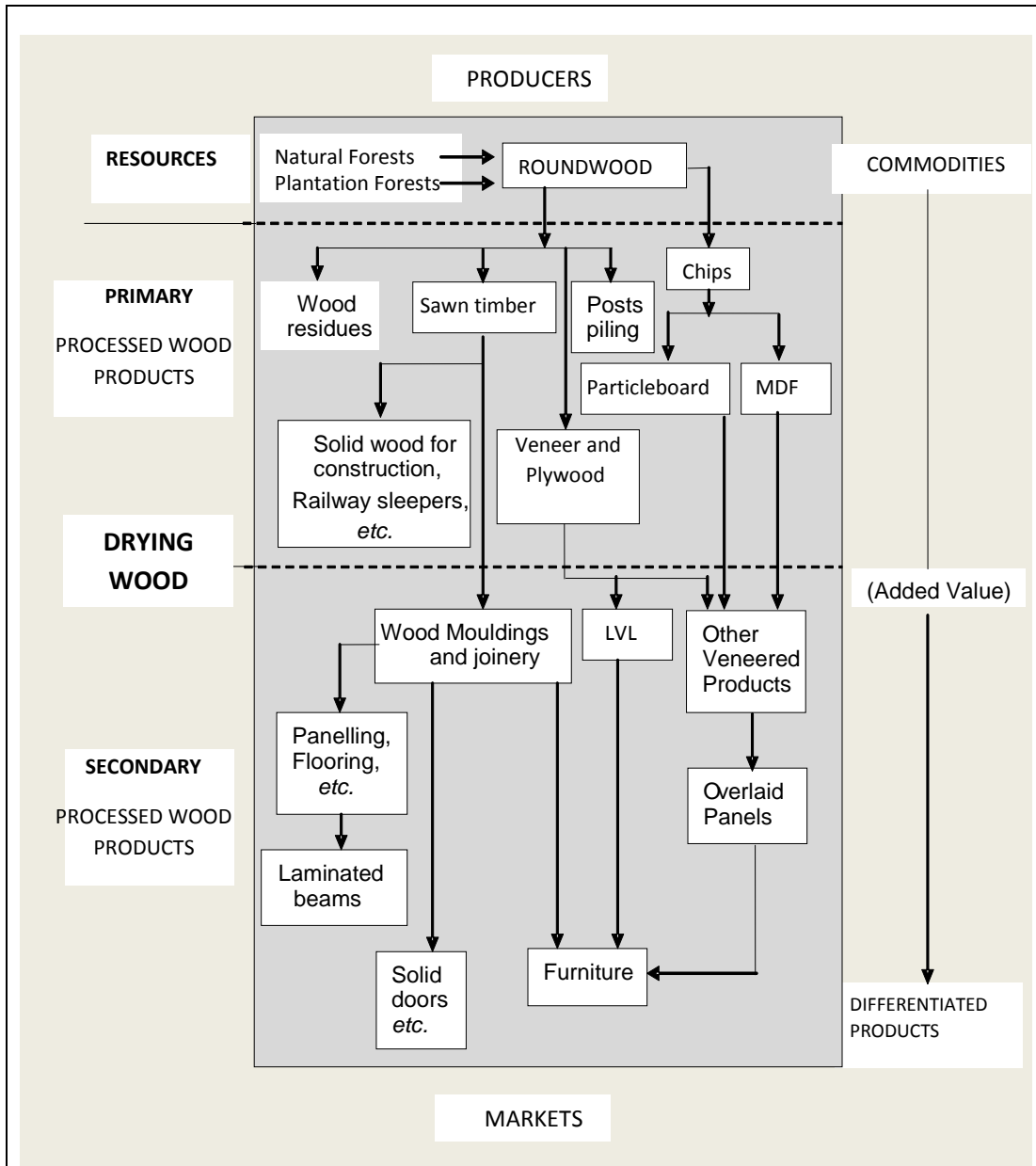

**Figure 1: Typical production chain - Timber processing**

### 2.1.3 Product Mix Selection.

Product mix selection **should** be generated based on maximization of value and volume of recovery in the sawing operations. Products are differentiated into dimensional/structural lumber and non-structural lumber.

Cutting to order, depending on the range of sizes required (long lengths - 12 feet (3.66m) and up) does not allow optimization of recovery, as a limited range of target sizes preclude the operator from cutting to get maximum volume or the widest possible board from each flitch sawn.

Therefore, shifting from cutting to order, to random length and width cutting will show an increase in recovery of prime lumber and much more could be recovered if the production was for random

length and random width down to 1 foot (0.3048m) in length. Material for flooring can vary from sizes ranging from 1 foot (0.3048m) to 7 feet (2.13m) in length with a 4 foot (1.22m) average. End matching of the dried boards where a tongue and groove is cut into each end of the board is needed to enable short lengths to be used.

Value can be further increased by cutting out defects in lower grade boards and producing shorter lengths of higher grade wood yielding an overall increase in returns.

Cutting extremely long lengths of boards (above 20 feet or 6.1m) results in a decline in recovery of both volume and grade, for it is extremely difficult to produce straight lumber in long lengths and achieve grade due to the pronounced taper in long logs and the exaggerated effects of spring and bow in cutting long lengths.

Sawmillers **should** carefully select what orders and range of sizes they can effectively and profitably produce. Orders for products such as quarter sawn lumber **should** attract a premium due to the slower production rate and loss in volume. The company's goal **should** be to look for orders for as wide a range of sizes as possible and develop markets where possible for random length and random width lumber. This may require educating the market so as to encourage the purchase of a wider range of sizes.

## **2.2 Logs - Raw Material input**

### **2.2.1 Cutting/Forest Management**

An understanding of the market requirements and an inventory of forest resources can help in selecting the best tree to cut and bucking the log to required lengths, hence reducing the amount of waste generated after processing.

It is recommended that trees are cut as close as possible to ground level, using proper felling techniques (directional felling) so as to prevent internal fractures within the log. The bucking process in forest **should** match final use/product requirement so as to minimize cut off residues and wastage in the trimming process.

Directional felling techniques **must** be practiced to minimize damage to the residual stand, reduce splitting in logs from felling activities by plunge cutting, improve safety by better control of the tree and improve recovery by ensuring cuts are perpendicular to log length.

The ends of logs **must** be protected with wax, sealed with an appropriate sealant, or insertion of an S-iron to minimize splitting and end checking from occurring if the log will not be processed within 1 week of cutting.

Requirements for timber harvesting/forest management are detailed in the GFC's Code of Practice for Timber Harvesting.



Logs that are protected to reduce splitting and drying out at the ends will improve recovery and quality whilst being processed.

**Figure 2: Logs protected with S- hook and sealed, and untreated log drying out and splitting at end**

### **2.2.2 Transportation of logs.**

Care **should** be taken when handling logs with mechanical handling equipment (eg. loaders) to prevent any damage and logs **must** be transported without a long overhang on the trailer, as the whipping motion causes splitting at the flex point of the logs which will affect the quality of lumber produced from the log.

## **3.0 SAWMILLING REQUIREMENTS**

This section details recommended best practices and requirements based on applicable policies and laws of Guyana, ongoing research and practical experiences. It is expected that conformation to the requirements of this section will facilitate operations in meeting their legislative requirements, and greatly contribute to improving the efficiency and competitiveness of the sector and individual businesses, and enhance the quality of the outputs/products of sawmilling operations.

### **3.1 Legal requirements**

Legislative requirements relevant for wood processing operations are as follows:

- The Environmental Protection Act
- The Occupational Safety and Health Act
- The National Insurance and Social Security Act,
- Public Health requirements
- City/District Bylaws requirements, and
- Labour Act requirements

It is important that the management of a wood processing operation have a clear understanding of the stipulated legislative requirements in order to effectively plan and manage their operations in order to comply with the relevant requirements. Some of the specific details in relation to wood processing operations that are stipulated in the statutes listed above are outlined in Sections 6, 7 and 8 of this document; however management is advised to work with the relevant agencies to obtain copies of these documents so as to ensure that they are in compliance with the relevant legislative requirements.

### **3.2 GFC Requirements:**

All operational sawmilling and wood processing operations **must** be licensed annually by the GFC and hence will have to conform to the requirements for forest legality as established by the GFC. Their operations will be required to conform to the operating practices detailed in this Code of Practice and must have the necessary records to support their compliance.

Operations involved in export of wood products **must** conform to the requirements for forest legality as established by the GFC.

### **3.3 Design of Sawmill**

#### **3.3.1 Sawmill Design, Type and Layout.**

Sawmill layouts and equipment configuration **must** be designed to achieve the desired output and recovery levels with a minimum disruption to the smooth flow of material through the mill with the minimum use of labour. At the same time, the design **should** be such that it can adapt to producing products based on changes in the market requirements.

Accessory equipment to move material onto and off the headrig, to the edger saw and out the edger to the green chain, is as important as the sawing equipment. Careful planning **should** also be paid to waste handling for slabs and sawdust such that their disposal or movement does not in any way affect the operation of the saws or the health and safety of workers, and utilize the minimum of

labor. The equipment needs to be well designed and guarded to keep human beings away from any moving parts, especially blades, and have all the safety devices such as stops, anti-kickback fingers etc. to ensure safe operation of the equipment.

Use the services of the manufacturers or representatives to come up with an efficient or effective layout that best matches your requirements – they **should** be able to provide specifications, layouts and designs that will minimize the chances of a costly mistake or bottlenecks in the system. The user manual for equipment **should** be taken into consideration in making decisions at all times.

### 3.3.2 Sawmill System

To achieve the goal of optimal recovery of value whilst still achieving high production rates requires a sawing system that will break down logs accurately to the desired final lumber thickness. The aim is to have the flexibility to break down each log using different sawing patterns to suit the varying quality of logs being fed in, adapt to defects found as the log is opened up and cut for product/products required by the market.

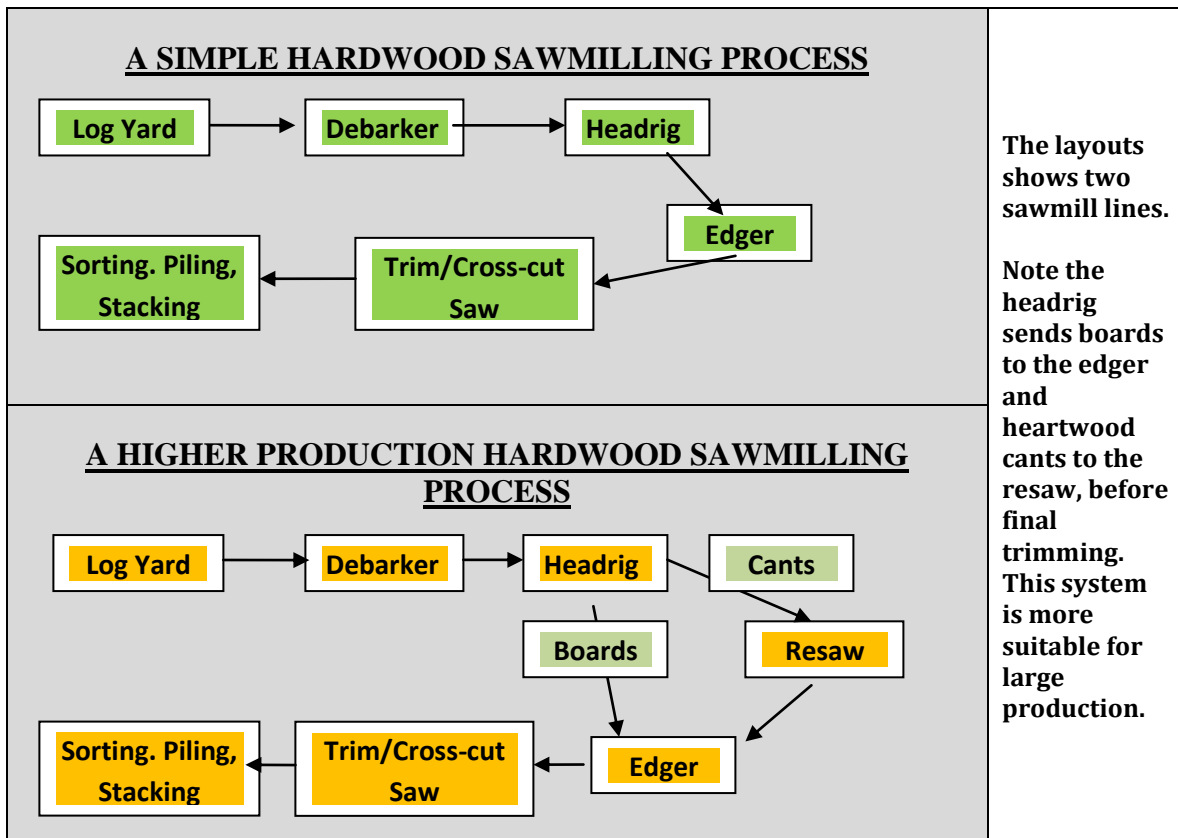

**Figure 3: Simple sawmilling process flow**

The typical sawmill system **should** consist of a single or multiple headrigs feeding to one or more edgers, or to an edger and grade resaw. Cants cut from the heart can be sent to a gang or band resaws for further processing into boards to speed up production without affecting production on the headrig – on the understanding that these pieces will yield minimal improvements in grade and value by turning to cut for grade.



### 3.3.3 Headrig / Breakdown Saw Requirements

To be able to maximize value in wood processing, during the headrig/breakdown process, the ability to turn the log is important. Turning the log whilst cutting produces higher quality lumber in wider boards by: sawing around defects, cutting for grade, tension reduction, flexibility to produce different products, etc. The ability to rapidly turn, clamp and taper set logs, and index the log or saw head for accurate sizing, becomes paramount to achieve realistic production levels in conjunction with higher grade and value recovery.



**Figure 4: Showing Bandsaw Headrig**

The following features are important to achieving maximum efficiency for the headrig/breakdown process:

- **Horizontal or vertical bandsaw** - with either a fixed carriage with moving saw head or fixed blade with moving carriage. Pulley size and blade sizes **should** correspond to recommendations of the manufacturer of the machinery or blades to suit the log size and density of the wood. Blade manufacturers clearly state what blade width and thickness, blade geometry and tooth pitch, **should** be used on what pulley size and with what type of blade guides.  
Fixed carriage with moving saw head is recommended because of the weight of Guyana's forest species of logs.
- **Laser and mirror** – a laser is useful when trying to set the depth of the first cuts on each face and to show the selected cutting line of the blade on the log. Similarly a mirror **should** be at the opposite end of the carriage so that at a glance the sawyer can see both faces of the log to optimize cut selection.
- **Computerized networks** - **should** be fitted to allow consistent product target sizing. Programming the machine with the desired thicknesses of product and with the kerf already compensated for, the blade can be moved to cut the next board quickly and accurately without mistakes.
- **Log Carriage** – the carriage **should** be strong enough to support the weight of logs that it is designed to cut. **Note:** Guyana's species can be 2 to 3 times as heavy as North American

and European species. Carriages **should** be fitted with power assisted log handling equipment to be able to rapidly turn, clamp or raise/outset either end of the log. Hydraulic operated systems are preferred as they provide stronger clamping forces. Power assisted functions on the log carriage that are recommended are –

1. Log turners –Chain type turners that turn the log in either direction allow more rapid manipulation of the log with less impact on the carriage.
2. Log loader or preferably a log infeed deck – With the capacity to lift/move the logs onto the bed of the mill given the weight of our logs. This **should** be under the control of the sawyer so they can quickly load the mill without recourse to manual labour or other personnel or unrelated equipment.
3. Taper rollers/sets or movable headblocks –To raise the small end of the log so that the blade will cut “in line with the bark” and so produce full length boards from the first cut out of the best part of the logs.  
Note: The blade will cut within the grain for the length of the log rather than cross grain, making it easier and faster to cut and therefore to longer blade life. An added benefit is that boards cut this way will have a consistent grain orientation and density throughout it’s’ length leading to a reduced risk of degrade when dried.
4. Log clamping – Power assisted clamps are necessary to hold the log in place against the side supports or bed to ensure consistent sizing and alignment and reduce the chance of blade damage due to log movement while cutting.
5. Vertical side supports– Side supports that move up and down on the side of a clamped log without causing any movement in the log – especially important when the blade is embedded in the wood during the cut.

- **Board removal system** – A board removal system under the control of the sawyer allows the sawyer to inspect the exposed face of the log for defects and decide whether to continue sawing on that face or turn the log. It also reduces waiting time and labour in removing lumber from the mill.

### **3.3.4 Gang Rip Saws**

The rip saw can take already edged wide boards and cants and rip them into multiple smaller pieces in one pass significantly boosting production. It can significantly increase production by allowing the headrig to concentrate on cutting wide pieces that are broken rapidly with the gang rip.



**Figure 5: Showing multiple blade rip saw**

It **must** include an accurate and consistent feed system that adequately ensures the board is fed through the machine in a straight line to produce straight boards. It **must** have a moveable/ removable fence to aid in straight line ripping. Ideally all blades **should** be moveable either manually or remotely. The option of lasers showing the saw lines on the lumber to be ripped would be an asset.

Gang rip saws **should** have enough blades to cut both sides of each piece being sawn from the wider board – i.e. to saw 3 - 1 x 4 pieces from a 1 x12 would require 4 blades to relieve the tension on each side of every piece sawn.

### **3.3.5 Board Edger**

A twin circular blade edger with at least two blades on one arbor, with at least one easily moveable by the operator, removable fence, a minimum 24 inches throat to take wide boards, variable feed system, at least a 2 inches depth of cut (preferably more to offer greater flexibility in cutting) and sufficient power to cut for the thicknesses desired given the density of species being processed.

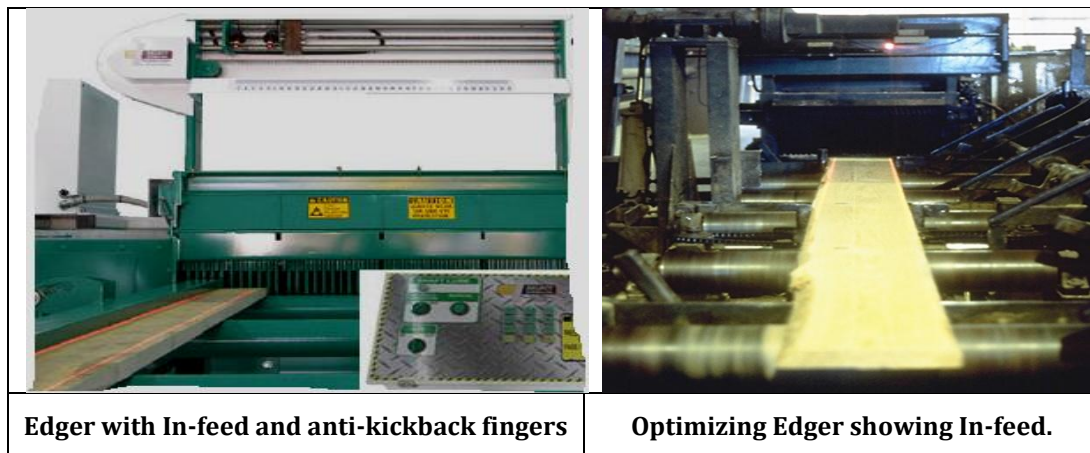

**Figure 6: Showing Board Edgers**

The edger **must** be equipped with anti-kickback fingers to prevent the boards being thrown back into the operator by the action of the blades. Gauges or lasers showing the position of the blades relative to the board to be edged are recommended for accuracy and optimization.

### **3.3.6 Trim or Cross-cut Station**

This process can be either a stand-alone unit or integrated into the green chain allowing for a free and efficient flow of material through the process. The station **should** have in-feed and out-feed tables and a length measuring system against which the piece to be trimmed can be referenced to match cut off lengths and optimize grade and length considerations.

The trim or cross-cut saw **must** be well guarded to prevent accidents, have sufficient depth of cut and power to adequately and safely cut the size lumber required. Saws **must** be mounted perpendicular to the end of the piece to ensure that truly square cuts are made.

Saw blades **must** be maintained to provide a smooth cut that shows no signs of tear out. It is preferable to have trim saws with lumber hold down mechanisms and foot pedal operation so that the operator can control the piece properly (if using a manual hold down system) or can keep hands away from the equipment.

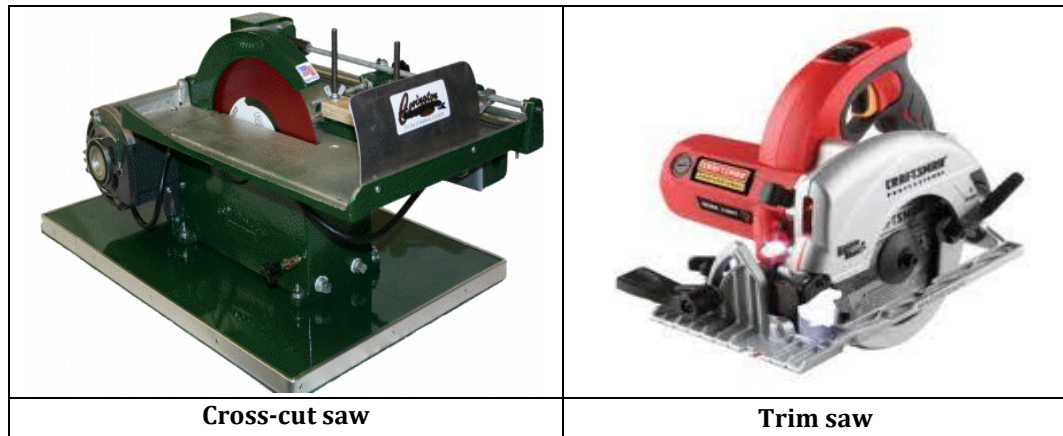

**Figure 7: Showing Trim or Cross-cut saw**

### **3.3.7 Accessories to Enhance Productivity and Reduce Costs**

These are designed to aid the flow of material onto and off the mill to maximize the use of productive machinery, remove choke points in the production line, and minimize labour in the process of handling material or waste.

- **Log cleaning system** – logs **should** be cleaned before being put on the mill. This will prevent foreign debris from prematurely dulling blades giving longer life and longer run times between blade changes to increase production and reduce the potential for fewer miscuts due to dull blades.
- **Debarker on the mill** – this typically is a circular saw blade that is installed on the mill that removes bark and dirt in the line of the cut or before the sawing operation, giving much longer blade life.
- **Log in-feed deck** – this **should** be controlled by the sawyer. It **should** be able to hold a stock of logs for the mill, sufficient to prevent waiting for more logs to be loaded.
- **Sawdust and slab removal system** – this **should** be mechanized and operate continuously to prevent a buildup of waste that could block or hamper the operation of the mill or edger.
- **Out-feed conveyors** – either powered or unpowered roller beds **should** be installed to transport the boards to the edger, green chain etc. with a minimum of labor and removing possible choke points that will hamper the operation of the headrig or create unnecessary waiting at the edger.
- **Transfer decks- should** be installed to shift material to the side to allow flexibility in layout or sorting of product. Many transfer decks have “flippers or kickers” to throw slabs or cants one way and slide boards the other way.
- **Staging areas** – areas before the headrig and between the headrig and edger or resaws **should** be put in place. These are to hold a stock of material to be processed such that a breakdown or stoppage in any one area will have less of an effect on the rest of the operation.
- **Green chains** – situated at the end of the line, these moving chains on a flat deck enable rapid grading, sorting and safe handling of the final end product. The green chain **should** be integrated with crosscut/trim saws to allow easy trimming or defecting by length.

**Note:** Efficient movement of material onto, on and off the saws has by far the greatest effect on overall production; much more than how fast a mill saws.

### 3.4 Log Yard Operations

Log yard practices are critical for the profitability and competitiveness of wood processing operations hence the operating practices **must** focus on maintaining the quality of the log during storage and processing logs as fast as possible.

The practice of just-in-time delivery to the mill **should** be implemented where possible through effective planning, to minimize time between felling and sawing, so as to reduce tension in the log. The more the log dries out at the ends; the more there is tension in the log, leading to loss of grade due to tension in the lumber and loss of volume from mis-cuts: Cutting dry logs increases the potential for further degrade in drying process.

Proper log inventory management **should** be implemented through the practice of a first-in first-out policy to reduce time to processing and prevent degrade of logs. Logs **should** be sorted by species, length, diameter, and quality class/grade to optimize log characteristics to end product requirements e.g. – use smaller diameter logs for box heart cants, or larger logs for quarter sawing lumber to improve recovery.

Log yards **must** be kept clean of debris and vegetation to prevent insect, bacterial and fungal growth that could transfer to the logs. Log yards **must** be well drained.

#### 3.4.1 Storage of Logs

Logs being stored for extended periods **must** be waxed/sealed with an appropriate sealant or have an S-iron installed, so as to prevent splitting and end checking from occurring.

Logs **should** be stacked in small piles, so as to avoid the lower stacked logs being in contact with muddy and sandy soil for extended periods and as much as possible, maintained wet to retain the moisture in the log so as to prevent the log from drying out.

#### 3.4.2 Preparation of Logs

Preparing logs before they are fed into the sawmill will increase production with minimal added cost. Debarking, bucking and/or washing logs before loading onto carriage to ensure cleanliness **should** be done to facilitate faster processing time for the log and longer life of the saw blade.

Logs with excessive crook, improper limbing (branch stubs left by not removing limbs flush to the log) and excessive butt flare can become handling and safety problems and delay the sawmilling processing; hence these **must** be removed before the log is loaded onto the carriage.

##### **Large logs.**

The average size of logs in Guyana is 3.3 m<sup>3</sup> and average small end diameter is in the 50 – 75 cm range, with only a very small proportion of logs being larger. Logs **should** not be cut into large cants off the heart centre as the cant will bow towards the bark side and lead to the production of low grade warped lumber (crook is a typical feature).



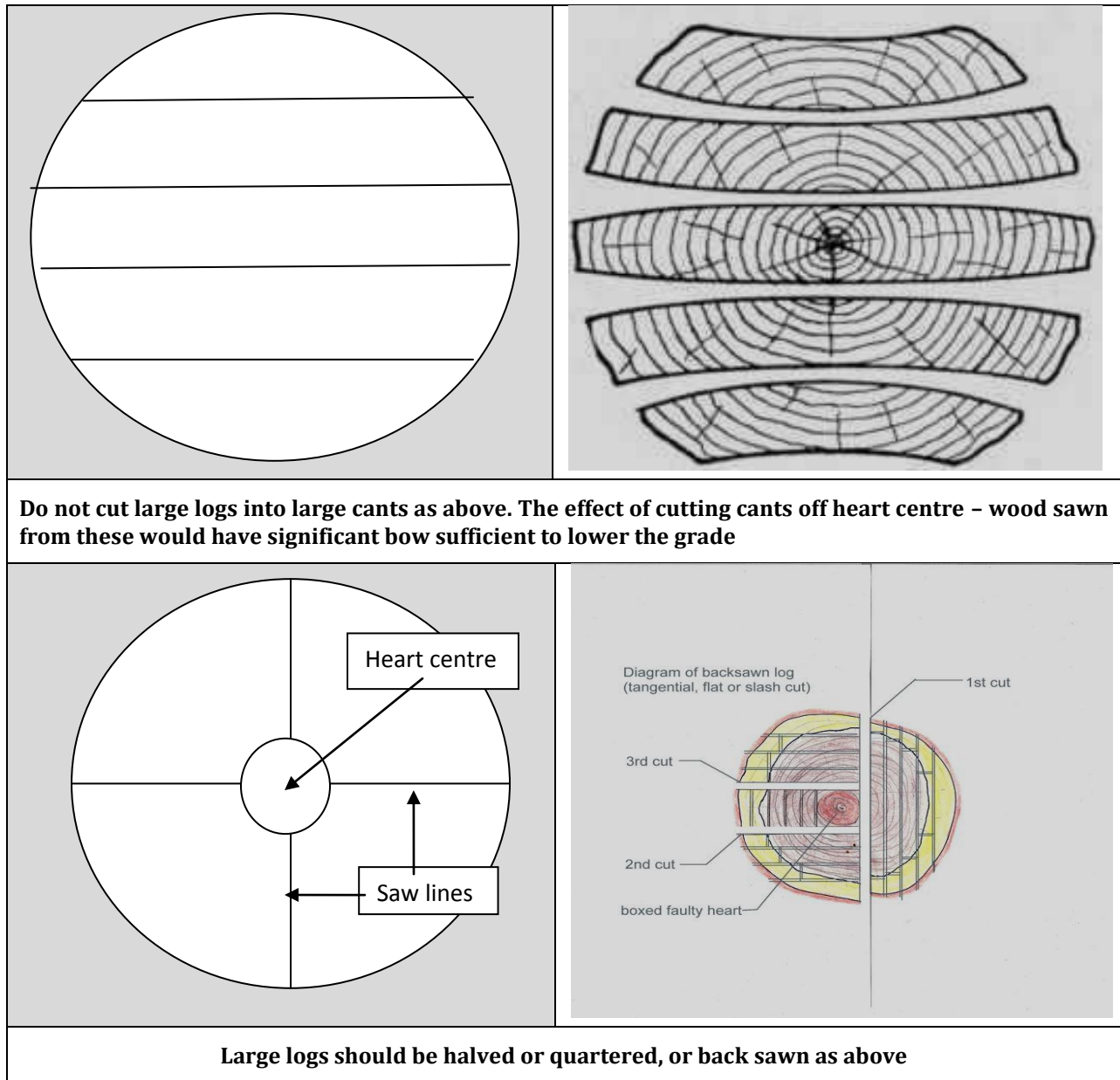

**Figure 8: Cutting large logs for processing operations**

In splitting any log it **should** always be cut in line with the heart of the log into equal or unequal halves or quarters (dependent on size).

### **3.4.3 Grading/Identify Open Face**

Selection and bucking of logs is necessary to maximize the quality of lumber and sawing decisions. This is critical for getting the greatest value out of a log based on log quality and product mix required. The logs **must** be graded prior to processing to identify the first opening face and sawing pattern to be used.

This process **should** be able to identify the defects in the log and determine the opening face and the sawing pattern to be applied so as to maximize the value of products, taking into consideration product market requirements/orders and use of equipment. The following must be taken into account:

- Log selection suitable to give the best returns for the desired lumber size – eg. It is considered more practical to use smaller logs for box heart cants as the heart is more likely to be sound in smaller logs and recovery and production is increased due to the minimizing of the number of cuts.
- Small logs **should** be sawn into 1 inch boards to minimize the effect of tension – 1 inch material can be stickered and stacked with weights on top to “straighten” the piece while drying.
- Small logs typically produce lower grade lumber. They **should** be live sawn to get the widest boards possible out of the log to be able to edge for the most volume of clear lumber. Live sawing also allows higher production rates by minimizing turning and reducing the number of cuts to maximize production.
- Sawing pattern based on the assessment of the log grade – typically it is not worth investing the time in turning the log and cutting for grade with poor quality logs. Low grade logs are cut into the largest acceptable dimension to get it on and off the mill as fast as possible – live or through and through sawing or cant sawing are typical choices.
- For short length orders it may be good practice to buck out the sweepy (bent) parts of a log to ensure that the bulk of the remaining log will provide clear straight lumber. The sweepy, short section can then be quickly live sawn and passed through the mill for a short length market.
- Logs **should** be graded by the quality of the four sawing “faces” on the outside of the log. The faces of the log **should** be selected based on the defects on the outside of the log (on the faces) for the best lumber in any log is typically in the “jacket” or the wood between the heartwood and the bark.
- Selection of the position of the first opening cut is made relative to the identified defects on the outside of the log where the best grade lumber typically is – this “first opening face cut” is the most important cut on any log as it defines the position of all the other cuts on the log and the ability to get the highest volume of grade.
- Some species of logs do not have knots and hence the defect of the heart center is most important in determining the “first opening face” so as to maximize the recovery of grade or value of lumber.

Whilst the sawyer needs to understand grading of logs and lumber, it would be helpful for the log grader in the logyard to mark the first opening face cut on the small end of the log which is then confirmed by the sawyer before the first cut is made. This would make the work of the sawyer easier as they would not need to leave their operating station to check the log; hence slowing down the production and would help in preventing mistakes.

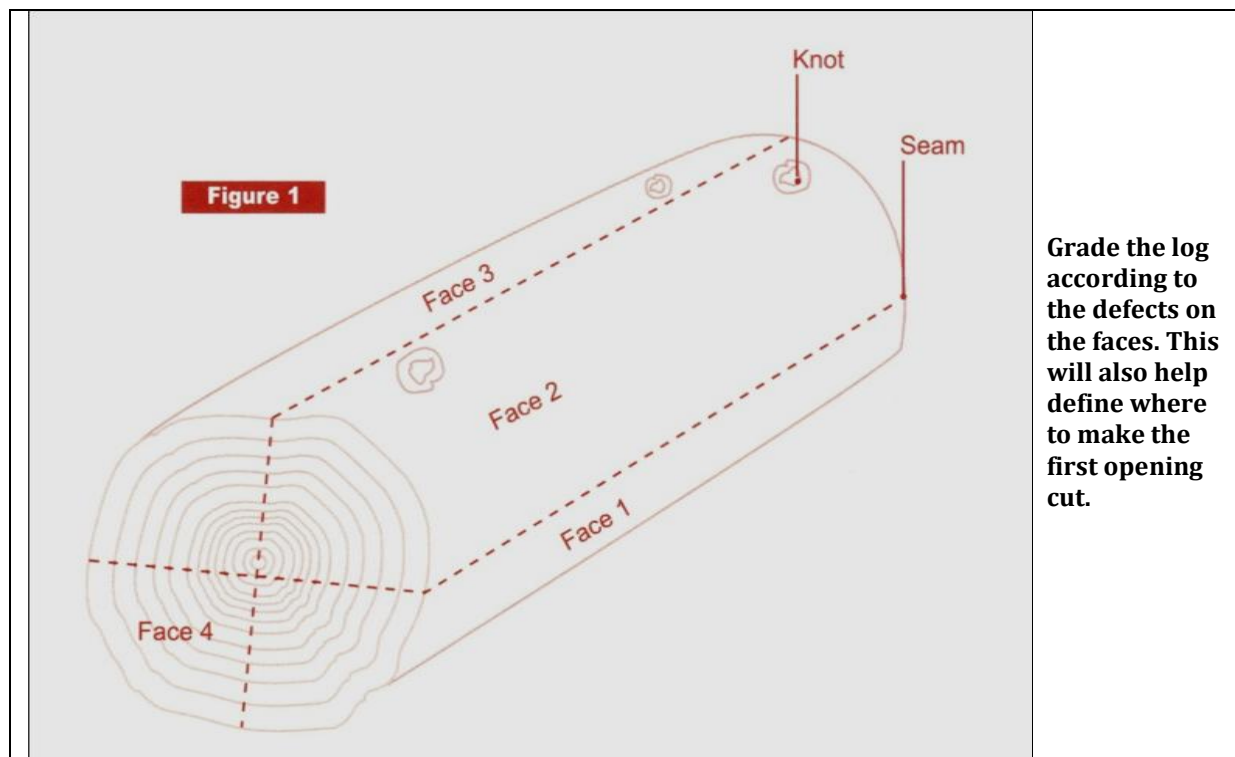

**Figure 9: Grading of logs to identify faces.**

Defects located away from the ends of the log and further down on any of the faces are far more important than those near the log ends, because these defects have large effects on grade determination, and proper face placement is important.

### **3.4.4 Log Loading and Orientation**

To improve productivity and sawing practices the log grader **should** pre-mark the log indicating the face or location of the first cut prior to debarking because it is difficult to see the log defects after debarking. Having the face/location pre-marked will reduce the sawyers process time, since he will be loading the log onto the carriage quickly and efficiently to achieve the production requirements.

**The pre-marking process should be informed by visible defects on the log, market requirements and the objective of maximizing the recovery of value from the log.**

Improved production can be achieved if each time a log is loaded onto the in-feed conveyor the butt end of the log is even ended in the same location each time for loading onto the carriage. This will reduce the time used for positioning the carriage correctly for log loading.

Optimal Log Orientation: Defects **must** be located when possible towards the edges of the faces. By doing so, most of the defects will be positioned on the edges of the flitches when sawn and can potentially be trimmed or edged off to increase the grade or value yield of the produced lumber.



## 3.5 Sawmilling Operations

### 3.5.1 General

The benefits of cutting for grade far outweigh any gains that can be achieved by volume production, for it generates the greatest net value from the resource. This concept encourages the realization of small gains at every stage of processing to achieve the greatest returns. Grade can be recovered/improved at each stage of the processing chain by operators at the headrig, resaw, edger, trimsaw, etc. They are required to make critical decisions which culminate into increased profitability and competitiveness.

The most critical single factor in the creation of system of cutting for value is the people involved. Knowledge, ability, and motivation of personnel at all levels of the organization, far more than equipment or finance, dictate whether any processing entity will be viable and sustainable or wasteful and unsustainable. Given this, there can be a vast differences in performance of a sawmill through the creation of a truly professional workforce.

This well trained workforce **must** include the owners, managers and operators who are knowledgeable about maximizing the efficiency and effectiveness of the equipment to capitalize on value recovered. Operators, supervisors, managers and owners **should** be trained in specific aspects of the operation to ensure they can comply with the guidelines and practices set out in this Code, as well as in log and lumber grading so they can make the necessary sound decisions required to maximize the value obtained from the log.

### 3.5.2 Primary Log Breakdown/Headrig/Resaw

The headrig/primary log breakdown operation **must** be under the control of a competent/certified operator who is experienced in the operation of the headrig, to be able to achieve the highest value/grade from the process, based on requirements of the market. He is required to make decisions that will affect other downstream processes and product requirements/quality. In order to make the right decision in maximizing the value of the lumber obtained from a log, the following **should** be considered.

- Log selection for grade and size to best match the market demand and lumber sizes to be cut.
- First opening face solution.
- Deciding when to turn to maximize the grade on each face.
- Deciding where in the log to saw different sizes from.
- What size heartwood cant to send to a resaw to optimize volume and grade production.

The operator will also have to determine the taper setting to use so as to skew the log on the carriage, so that the saw will travel the desired path during sawing. There are three types of taper-set options that can be used:

- No-taper: most effective when sawing the low grade face
- Split taper: in sawing for grade this practice will keep the center of the log or pith from appearing partially on flitches sawn. This option **should** not be used when sawing medium or high grade logs.
- Full taper: when the desired opening face potentially will yield a high-grade flitch the full length of the log.

Cant and Heavy Flitches can be taken directly from the headrig to the resaw for further processing in an attempt to eliminate the bottleneck at the headrig, where the Resaw Operator needs to make decisions on what to saw from a given cant delivered to ensure the greatest recovery of value.

The saw blade on the headrig **must** be constantly cooled to ensure production volume and that the quality of products are maintained.

**There are fully automatic/computerized headrigs, resaw and edger that are used in high production wood processing operations. In the operation of these sawmilling equipment, the logs and flitches are scanned to provide data, which is then computed to set parameters to make a decision on the cutting process. This decision is usually based on obtaining the greatest value from the log or lumber.**

### 3.6 Sawing Patterns

The choice of sawing pattern **must** be made to balance production volume with quality, to achieve the greatest value in the shortest time, with the minimum of material and cost – the choice **should** be based on whatever balance of production, recovery and lumber price gives the highest overall return.

The factors that are used to guide the selection of the sawing pattern in the conversion of logs into lumber are:

- Log quality – grade, shape, defects, taper, sap wood, etc.
- Log size – short or long, big or small diameter.
- Product dimensions required.
- Species of wood.
- Equipment capability
- Balancing material flow in the mill
- Market demand for particular grain pattern on the face of the boards – i.e. characteristics like a “flame” pattern” (achieved by cutting across the grain rather than with the grain) or for a specific orientation of the grain in the end of the boards like quarter sawing (produces more stable lumber with no tangential shrinkage).

The main sawing patterns discussed are –live sawing, cant sawing, quarter sawing, grade sawing and back sawing.

The sawing patterns suggested here are based on a system of cutting the final board thickness on a headrig and sending the flitches/ boards to an edger to optimize both the grade and/or volume recovery with the possibility of further grade/volume recovery at the trim/cross-cut saw.

#### **3.6.1 Live-Sawing**-sometimes called plain or through-and-through sawing

This is probably the most common method used in Guyana to produce wood in Guyana and is typical of production from sash gangsaws as it is the fastest and easiest method to produce lumber.

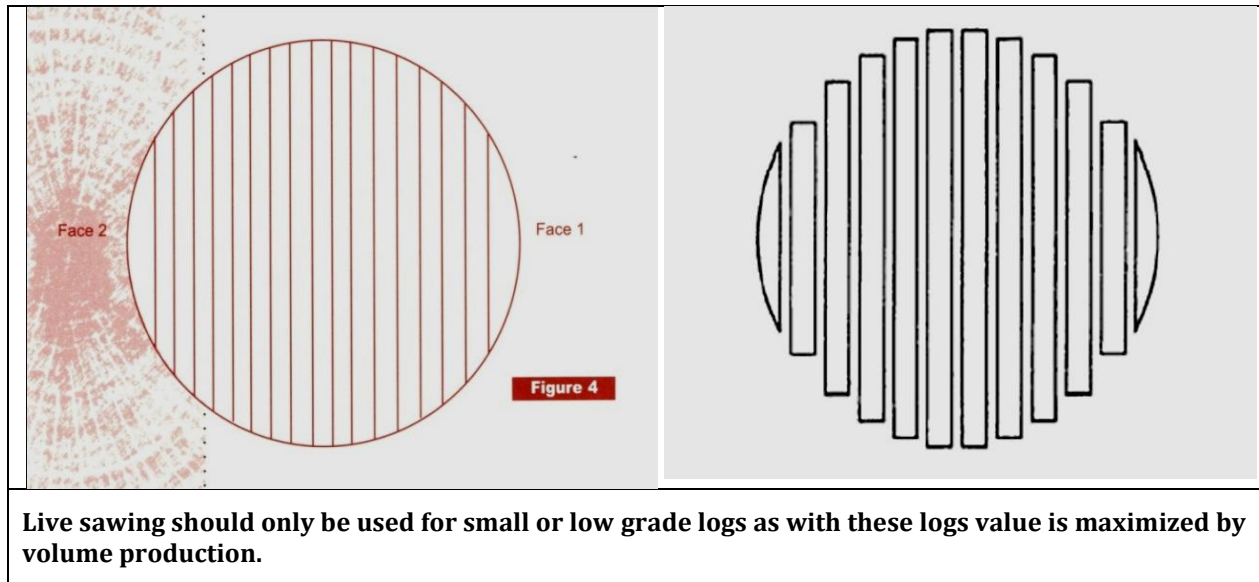

**Figure 10: Steps in conducting live-sawing**

Live sawing therefore always produces a much higher proportion of lower grade lumber than other methods, especially with medium to high grade logs. Typically, the increased production from this method cannot compensate for the loss of value from a lower grade recovery. As a consequence this sawing method **must** only be used in the following scenarios:

1. Small logs typically have lower grade lumber in them so to get most value from them it is better to saw them as quickly as possible to offset the loss of grade with a higher volume of production. Small logs also give lower production than large logs so it makes sense to saw them as fast as possible. Given the high tension in juvenile logs, it is better to cut small logs into 1 inch boards so they are more easily “flattened” out in the drying process.
2. Defective logs are best passed through the mill and sawn as fast as possible (if there is no alternative but to saw them) and sawn in the largest sizes possible to return the mill to sawing better quality and higher value logs quickly.
3. Logs with pronounced sweep or crook **should** also be cut into short lengths and 1 inch material so that variations in grain orientation and density along the length of the boards can be stabilized through drying under weights to keep the lumber straight.

### **3.6.2 Cant Sawing.**

With this method, the outer portion of the log on faces 1, 2, 3 and 4 are cut into boards with the remaining piece (called a cant) being sent to a secondary breakdown saw or sold in cant form without further processing.

The cant **should** have equal amounts of lumber taken from the each side so that the heart is centered to help the cant keep straight. Care **should** be taken in high tension species to not saw too deep on any one face, but to remove the sapwood/tension wood on all four faces evenly as shown in Figure 11. Cutting too deep on two opposing faces can cause the tension in the two uncut faces to pull the cant apart or split the cant.

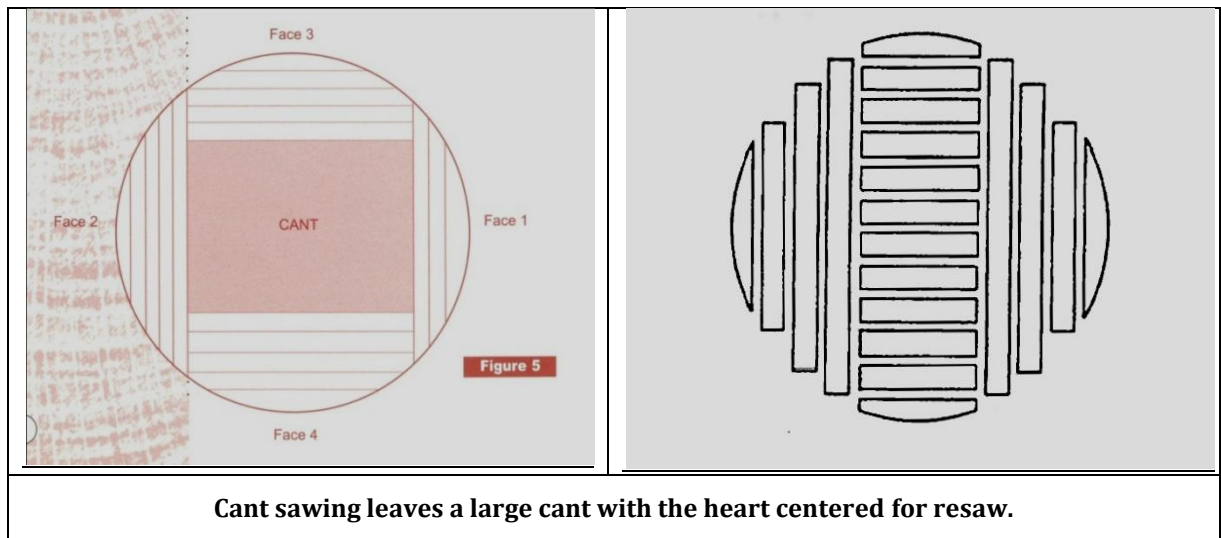

**Cant sawing leaves a large cant with the heart centered for resaw.**

**Figure 11: Steps in conducting cant-sawing**

Cant sawing **should** be used to maximize the overall production in mills that have secondary resaw capacity as it allows the best grade to be taken off the outside of the log by the headrig and the more defective, lower grade centre to be sent to the resaw for rapid breakdown to the final product size. This method maximizes the productivity on the headrig as it restricts the number of cuts necessary there.

### **3.6.3 Quarter Sawing.**

Quartersawn lumber is defined as lumber cut to orient the growth layers between 45 to 90 degrees of the face (widest part) of the board. Fully quarter sawn is when the growth rings are oriented between 80 – 90 degrees of the flat face of the board. Customers **should** be clear with sawmills as to what type of quartersawn material they want.

This technique **should** only be used to meet customer requirements for more stable lumber or for a specific “look” to the wood, typically a flat, “Clean,” straight grained face with some small flecks in the face of the boards.

Quarter sawing **should** only be used as an option to either match specific market requirements as defined below or to prepare big logs to be handled by smaller log capacity sawmills.

- The lumber is much more stable during drying and in service, as the vertical orientation of the grain in the ends of the board cause it to shrink evenly on its wide face or thickness without cupping or checking. All the shrinkage will be concentrated on the thickness so boards that are quartersawn will need to be sawn thicker (with more thickness tolerances) than live sawn boards to compensate.
- The lumber will not shrink/swell whilst in service, so it is recognised for producing wide pieces of lumber that stay flat in service – ie. wide plank flooring, table tops, and cabinet doors from solid pieces of wood (as opposed to ripping strips and edge gluing).
- It produces clean, straight grained boards preferred by some.
- Quartersawn boards are much more resistant to wear in service – preferred for high traffic areas.

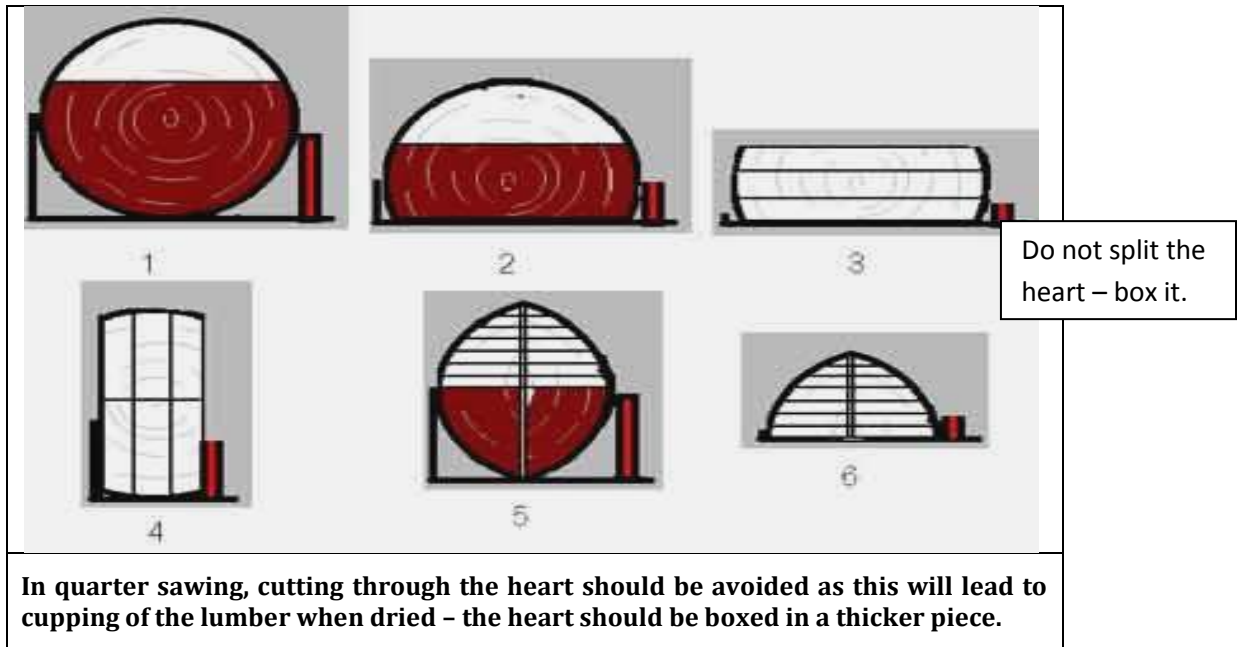

**Figure 12: Steps in producing quartersawn lumber**

When choosing to produce quartersawn lumber, the owner **should** ensure that they are properly compensated for their loss of production and recovery from the round log by the price they are offered for the lumber. Buyers also need to understand what they are asking for and why.

### **3.6.4 Grade Sawing.** Sometimes referred to as “sawing around”.

Grade sawing is essentially a process of cutting around the heart to achieve the highest proportion of clear, defect free lumber from a log as it is opened up. It offers the flexibility to maximize grade from medium to high grade logs and yet still be flexible to change the cuts and switch to a higher grade face, as defects are encountered on opening up the log. This technique is the most effective in deriving the greatest net value from most logs and **must** be used for sawing medium to high grade logs.

It involves selecting the first opening face and sawing it until the log starts to spring or until the grade on that face worsens, then tuning to the next face and repeating the process until all the high grade flitches are removed.

#### **Technique for grade sawing**

Grade sawing if done properly (turning 180 degrees), balances the grain pattern across the end of the board, balancing tension and compression in the lumber, such that the piece sawn will stay straight - turning 90 degrees does not achieve this as the end grain is unbalanced in the piece. By turning 180 degrees the operator can keep the heart centered and reduce the stress in the log and prevent loss of grade due to tension in the lumber. It also makes it easier for the Sawyer to arrive at their final center cant dimension with little or no trim cuts.

This sawing pattern relies on cutting the final product thickness on the headrig/prime saw or in combination with a grade/line bar resaw (for greater production) and sending the sawn boards/flitches to a separate edger to optimize either the volume or grade recovered from every

piece of board sawn. For grade sawing to be effective, it needs to be combined with sound “first opening face decisions” and taper sawing.

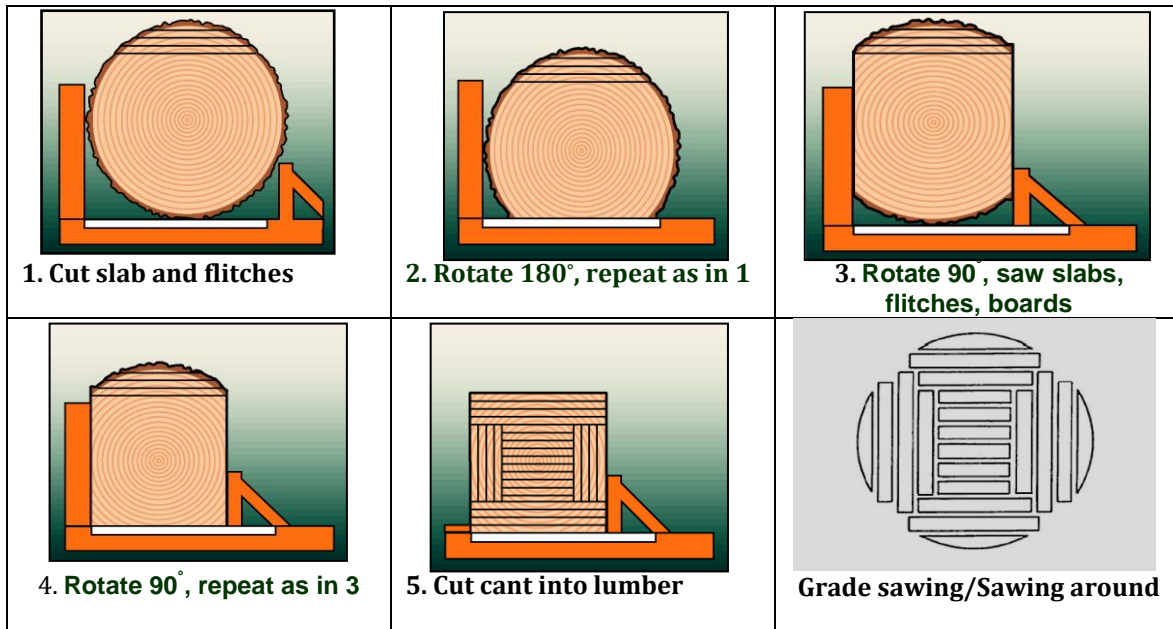

**Figure 13: Steps in conducting grade sawing**

The advantages of grade sawing are:

- When combined with taper sawing (cutting in line with the bark) and sound “best opening face/ worst opening face decisions,” it is by far the best method of achieving the maximum volume of high grade lumber and therefore value from the widest range of log grades. Given the variation in pricing on lumber grades, this method will always generate the greatest dollar value from round log volume. It more than compensates for a slightly lower production rate due to the need to keep turning the log.
- Produces relatively flat sawn lumber with the end grain balanced in the lumber to ensure there is no warping of the piece.
- Requires much less edging than live sawn lumber. In addition, edging decisions are much simpler as the edger operators have more time to treat each board on its individual merits and rip to recover grade.
- It offers the flexibility to turn the log as defects are encountered when opening it, to be able to get the highest grade lumber out of even the lowest grade logs.
- Keeps the heart centered to minimize tension in our high stress wood and reduce loss of grade in boards due to tension (when turning 180 degrees). It can help minimize loss of grade due to tension caused by log ends drying out.
- It offers the ability and flexibility to optimize grade recovery at both the headrig/prime saw and at the edger - the headrig can saw to either avoid defects and produce grade lumber or locate knots on the edge of each flitch or boards so that they can be edged off to achieve grade with minimum loss off volume.
- Turning 180 keeps the end grain balanced in all the boards sawn giving a much higher proportion of straight lumber and minimizes the volume of lumber from each log that needs edging.

- When combined with a gang rip after the edger, high volumes of high grade, straight lumber can be sawn.

**First opening face** – the log needs to be assessed based on the defects found on the outside of the log as below –

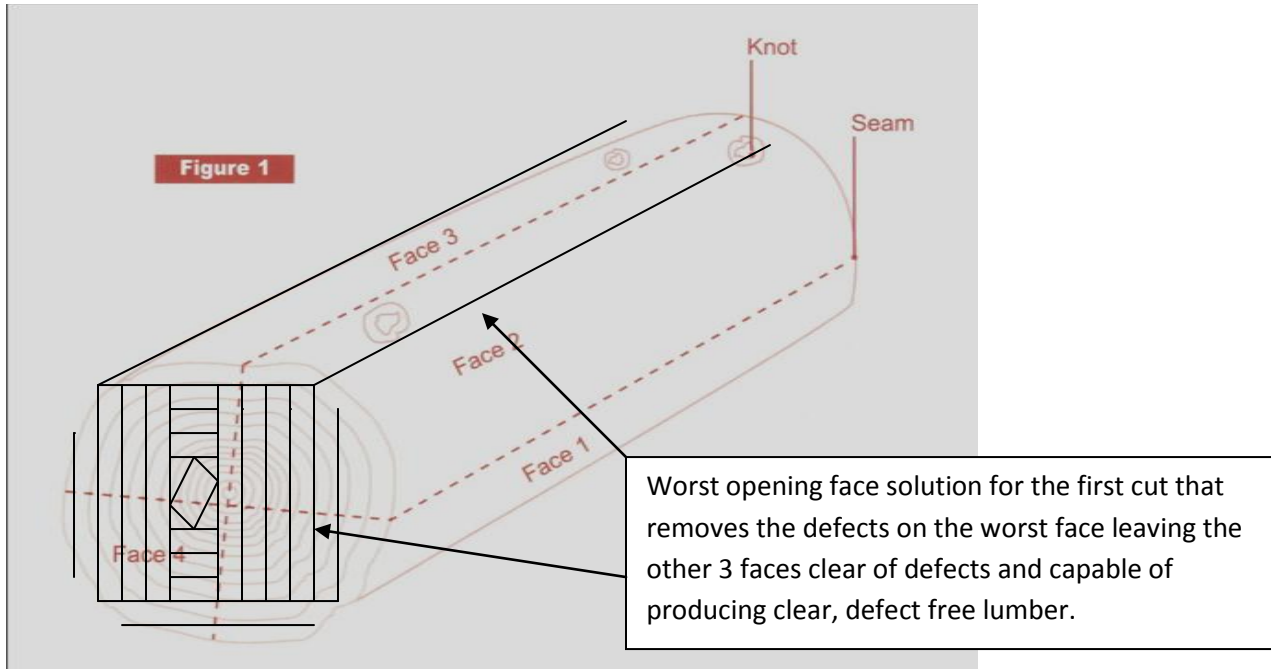

**Figure 14: Grade sawing based on opening face to remove defects on outside.**

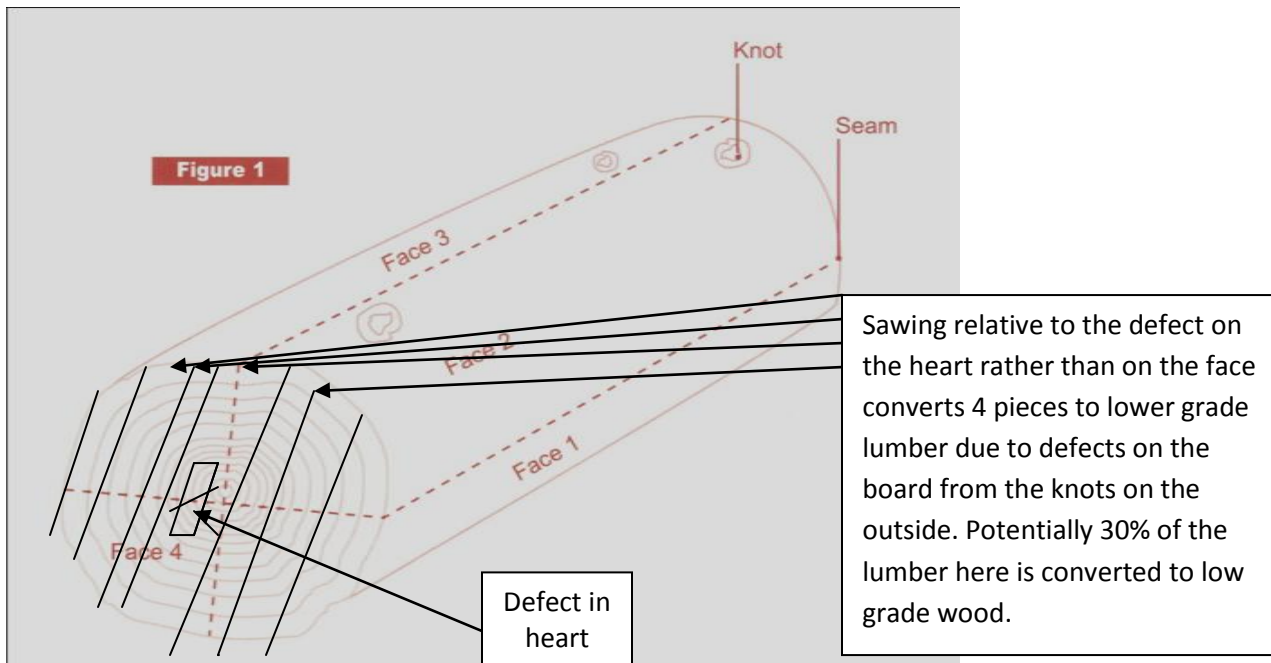

**Figure 15: Grade sawing based on cutting in line with defective centre**



The disadvantages of grade sawing are:

- Grade sawing requires a high degree of operator skill.
- Grade sawing has lower production rates than live or cant sawing but typically the recovery of grade and value more than compensate for any loss in production.

The best lumber is found in the “jacket” of the log (the area between the heart and the bark/sapwood), therefore the operator **should** concentrate on getting the most grade and volume out of the best part of the log. The operator **should** focus on having the defects (knots, splits etc) on the outside of the log being to the edge of the flitches so that it can easily be edged off to produce high grade lumber.

### **Grade sawing using taper**

This process entails raising or setting out the small end of a log such that the blade cuts in line with the bark and produces full length lumber from the first cut rather than short lengths if the log was lying flat on the bed of the mill. The log is sawn on the best opening face with full taper which will convert the best lumber in the jacket of the log to the maximum volume of high grade lumber from that log, or on the worst opening face without taper so that the low grade pieces from that face are converted to shorts and when the log is turned 180 degrees to the next face, the blade will cut in line with the bark on the better face.

By raising the small end of the log and cutting in line with the bark there is an increase in the volume of high grade lumber that is recovered from the “*jacket*” of the log when compared with leaving the log flat and cutting into the taper of the log. For mills with manual log handling, taper sawing can be achieved by putting shims under (horizontal mill) or at the side (vertical saws) to achieve the same result.

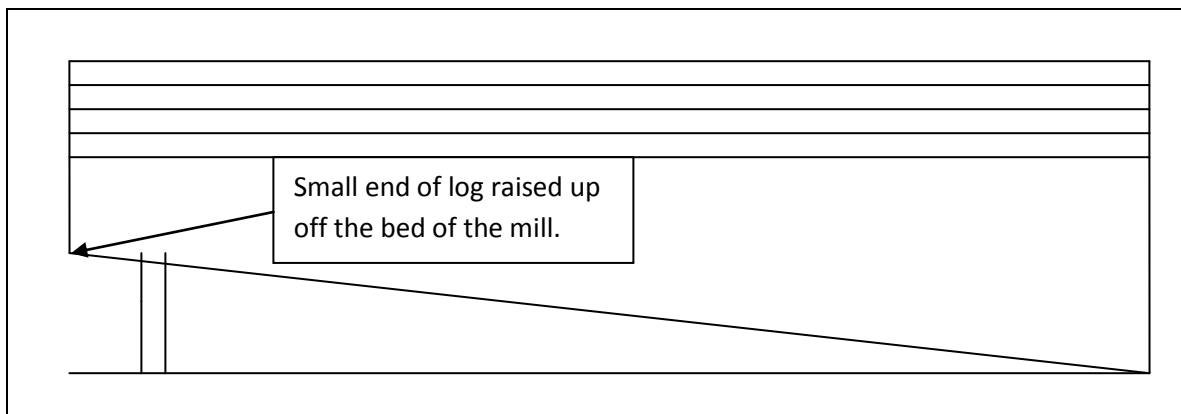

**Figure 16: Use of taper to raise logs and cut in line when opening best face**

For the worst opening face solution the operator **should** only saw deep enough on that face to produce a flat base to support the log when it is turned 180 degrees to the opposing better face to allow him to cut in line with the bark on that face.



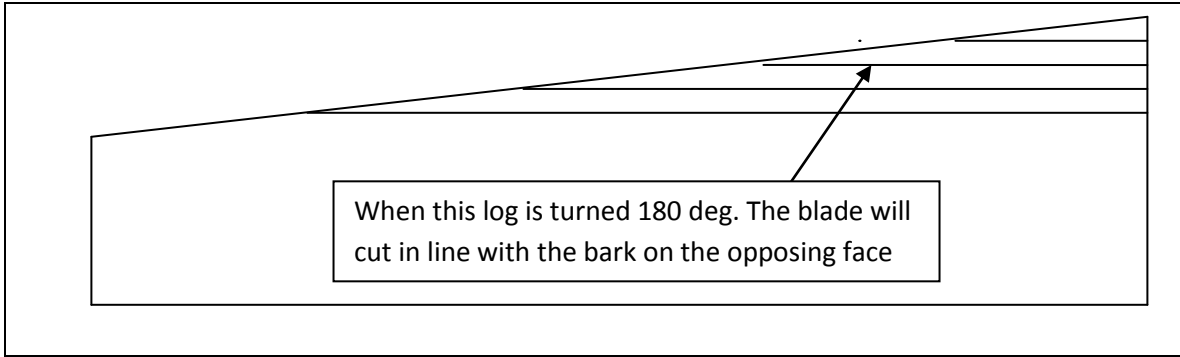

**Figure 17: Non use of taper to cut into worse face opening**

An added benefit of taper sawing is that the blade is cutting within the grain of the wood rather than across the grain, leading to easier cutting, faster cuts, less chance of mis-cuts, longer blade life and consistent wood density throughout the length of the board. With consistent density, there is less propensity for the board to warp when put to dry. Boards that are partially cut across the grain have varying wood density in them and as such will dry unevenly across their length leading to greater potential to warp.

**Note:** Logs **should** always be cut from the small end to the large end to give the operator a better reference when making the first cuts and arriving at the final cant dimensions. It also reduces the chance of mis-cuts by avoiding the blade having to cut wide into the harder “butt” end of the log.

**Note.** It is suggested that when logs are dried-out, they should be cut into 1 inch material as there is a better possibility of removing the warp caused by tension in the drying process through applying weight to the lumber stack, humidifying the lumber at the beginning of the drying process and equalizing the lumber at the end.

### 3.6.5 Back Sawing

Back sawing is commonly practiced by sawmills cutting larger diameter forest logs. The prime concern is to avoid defects and to anticipate embedded defective locations if any.

- Step 1: Log is cut into halves (if no visible core defects occur); known as the breaking cut.
- Step 2: The location where placement of the breaking cut is crucial as it dictates subsequent recovery.
- Step 3: The halved logs are then sawn around to produce flitches, followed by either saw-around or live-sawing to convert into intended sizes. Pith and log defects are avoided as much as possible during each cut.

The location of the first breaking cut can be used as guidance to examine the location of other defects. This will assist sawyer in making the subsequent cuts.

This sawing pattern produces better value recovery compared to live-sawing and faster production rate compared to sawing-around method.

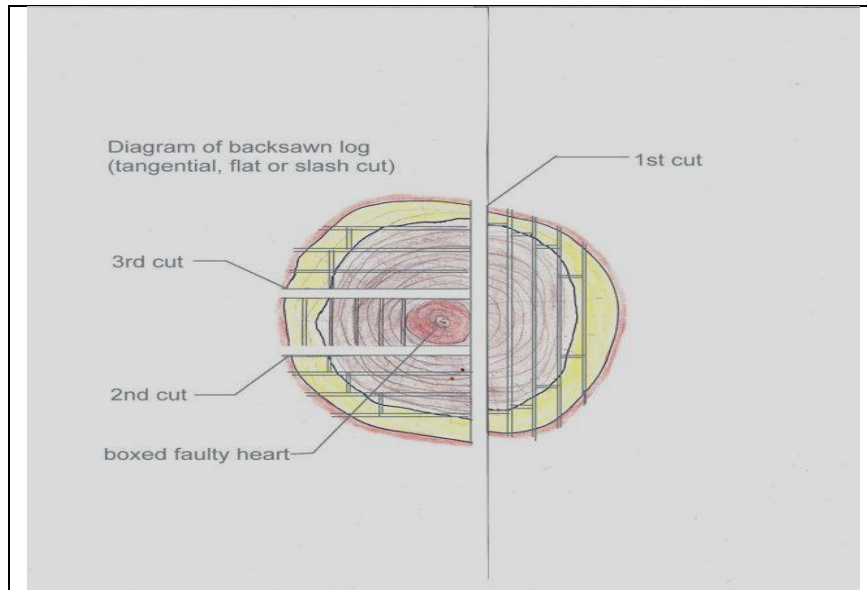

Figure 18: Steps in back sawing logs to cut around a defective heart

### 3.7 Edger Operation

Mill management **should** determine if optimizing to a specific grade rule requirement is the appropriate objective, for a sawmill producing lumber for furniture or cabinet shop would achieve greater value and recovery through optimization of random width. This is an issue that needs to be analyzed carefully in determining the proper operating procedures for the edger operator.

Edgers **should** have random width capability, for fixed width edging will always result in the operator over edging the lumber and recovery losses being incurred.

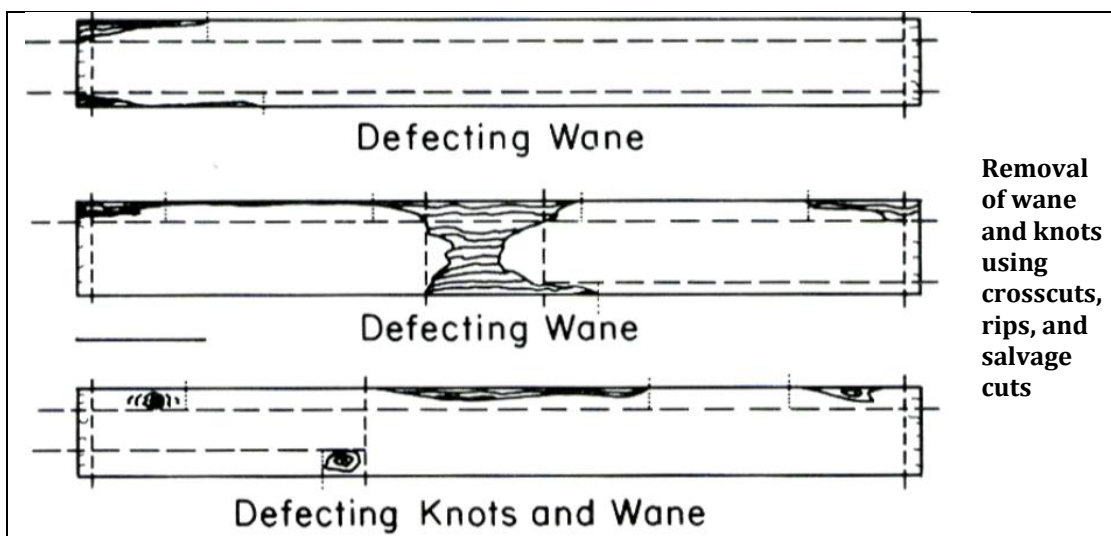

Figure 19: Optimizing value in lumber by removing defects

A skilled edger operator with enough time to make good edger judgments with laser lines indicating the saw cuts and good in-feed equipment, can edge lumber to meet specific industry recognized grade requirements.

**The operator of the edging process should be informed by visible defects on the board, grade and value of lumber, market requirements and the objective of maximizing the recovery of value from the lumber.**

### 3.8 Trim Saw/Cross-cut Saw Operation

Trimming/cross cutting operations can effectively improve the grade and value of lumber through decisions taken by the operator. The following actions associated with this process will ensure maximization of value of products.

- Lumber can be straightened.
- Long pieces can have defects removed to return a higher grade with minimal loss of volume.
- Final product sizes can be cut to match orders.
- Reduce the workload and increase production at the headrig and edger.
- Provide quality control for the whole operation.
- All ends **must** be sawn perpendicular to the longitudinal axis of the piece and then coated with a properly applied thick end-coating to reduce the likelihood of end-splitting during seasoning, shipment or usage.

### 3.9 Rough Planing

Rough planing helps value-added machine operators to detect defects, and aids in grading and sorting lumber as appropriate quality material as aligned with orders to minimize waste in ripping and cross-cutting operations. The opportunity to grade and select lumber before final processing will eliminate work pieces that are not good for the market.

Rough planing **should** produce a product that is more uniform in size which will improve the performance of secondary machines. The uniform size of the lumber will allow for better feeding and will increase production rates on all machines by reducing jam-ups.

Rough planing cleans lumber surfaces of dirt and grit thereby eliminating nicking and premature wearing of your finishing machine's knife in production runs. Clean stock being fed to finishing planers or molders will eliminate expensive downtime, short tool life, and high grinding costs.

### 3.10 Production Tolerances - Specifications for Rough Sawn Lumber

It is important that rough sawn lumber be cut with adequate oversize tolerances to allow for shrinkage to achieve the standard nominal size at 20% moisture content. Timber **must** be sawn to allow for natural shrinkage whilst still maintaining the quality and recovery value.

All industry stakeholders **must** adhere to the standard thickness sizes for rough sawn lumber specified in the Table 1 and Table 2 below, unless they are cutting to meet specified market requirements as detailed in an order/contract

**Table 1: Specified sawing size (thickness) for rough sawn lumber**

Ordered Size (Nominal)		Recommended Sawing Size (off the saw)		Maximum Oversize	
Metric (mm)	Inches	Metric (mm)	Inches	Metric (mm)	Inches
Under 25.4	Under 1			3.18	1/8
25.4	1	28.58	1 1/8	6.35	1/4
31.75	1 1/4	34.93	1 3/8	6.35	1/4
38.1	1 1/2	41.28	1 5/8	6.35	1/4
44.45	1 3/4	47.63	1 7/8	6.35	1/4
50.8	2	55.56	2 3/16	6.35	1/4
63.5	2 1/2	68.26	2 11/16	6.35	1/4
76.2	3	80.96	3 3/16	6.35	1/4
88.9	3 1/2	95.25	3 3/4	9.53	3/8
101.6	4	107.95	4 1/4	9.53	3/8
127	5	133.35	5 1/4	9.53	3/8
152.4 and over	6 and over	161.92	6 3/8	12.7	1/2

Table 2 specifies the recommended sawing sizes for widths of rough sawn lumber to allow for shrinkage when wood is dried to the nominal sizes at 20% moisture content.

**Table 2: Specified oversize (maximum) for width size for rough sawn lumber**

Ordered Size (Nominal)		Maximum Oversize	
Metric (mm)	Inches	Metric (mm)	Inches
Below 152.4 mm	Under 6	6.35	1/4
152.4 mm to below 203.2 mm	6 to 8	9.53	3/8
203.2 mm to below 254 mm	8 to 10	12.70	1/2
254 mm and over	Over 10	15.88	5/8

The oversizes for the widths specified are for the target width for flat grained lumber. For quartersawn lumber, the oversize is reduced to 50% because of less shrinkage expected.

Lengths of rough sawn lumber, unless specified differently in a contract, **must** increase in intervals of 304.8 mm (12") with a maximum oversize of 152.4 mm (6").

### 3.11 Chainsaw Milling

Chainsaw milling **must** follow the same sawing patterns, safety requirements, and guidelines as for sawmilling operations as detailed in this Code of Practice.

Free hand ripping can be used to take off the 4 slabs on the sides of the log and the boardmill used to resaw the side slabs and cant(s) cut from the logs.

The use of a boardmill with the chainsaw is recommended to rip lumber, for it provides added accuracy and improves the quality of the cut, which contributes to higher recovery of volume from round log volume and increases in grade of lumber produced.



**Figure 20: Use of Boardmill with chainsaw for processing logs**

The use of chainsaw to cut lumber of less than 2 inches in thickness is only allowed by special permission from the GFC.

A manual, “Turning Trees to Timber – A Chainsaw Milling Manual” By Nick Pasciecznik, Mark Brewer, Clemens Fehr and John Samuel outlines all aspects of chainsaw milling including safety requirements, equipment, and techniques.

## **4.0 QUALITY ASSURANCE ACTIVITIES**

### **4.1 Documentation/Record Keeping**

Relevant documentation and maintenance of records are necessary to support and facilitate effective and efficient operations of the processes within any company.

Documents such as procedures and work instructions **must** identify and detail the best practices being implemented by the company in its operations and records provide the evidence to demonstrate conformity to the recommended practices.

Documents outlining instructions are prepared in a user friendly format and can be either TEXT, pictures or a combination of both. Some areas where recommended documentation can improve the effectiveness and efficiency within an operation are:

- Instructions in relation to Occupational Health and Safety (OH&S)
- Operations where more than one staff is involved in the same operation.
- Maintenance and set-up of equipment
- Lumber size measurement (thickness)

Records are maintained based on their ability to demonstrate conformity to regulations, market requirements and performance based requirements established by the business entity. Some areas for which records **must** be maintained are:

- Inventory records: raw material (log) and final products.
- Production record: supporting chain of custody marketing requirements.
- Personnel records: employment history, training, payments, performance evaluation,
- OH&S records: activities, accidents monitoring.
- Maintenance records: machinery, operation and measurement equipment.
- Permits and licensing
- Customers/sales record
- Suppliers record

### **4.2 Training and Competency of Personnel**

Management **must** ensure that personnel with the necessary competence are available for the effective and efficient operation of the organization. The management **should** determine knowledge and/or skills an employee would need to be considered competent to perform a particular job and then determine if the employee performing the job possesses that knowledge or skill. If not, consider it as a training need and it **should** be addressed.

The attitude and skill of the operator will determine the performance of any machine being operated; hence it is most critical that the operator completely understand proper set-up, operating and maintenance procedures for all the systems. An investment in a quality machine will only reap the maximum benefits if it is followed by an investment into a skilled operator and an investment in on-going training.

Implementation of a Quality Control programme can greatly enhance product quality to the customer, and help reduce costs by minimizing waste at all stages in the processing operations. Some basic quality issues that can be addressed are:

- Improve understanding of log yield as well as revenue yields from sawn logs and resultant products.
- Training and certification of sawyers, graders, saw doctors, key equipment operators
- Training for millwrights – for sawmill and secondary processing machinery and equipment
- Improving sawing techniques.
- Measuring lumber after the headrig and at other stations more often to minimize and correct sawing problems that may have developed during normal operations.
- Put bunks down where necessary when flitches or lumber have to be accumulated prior to processing.
- Provide uniform sized stickers for green units for stacking either in the dry kilns or air-drying yard.
- Stop the practice of employees walking on the flitches, lumber or cants at any time during the process.
- Set-up an air-drying yard using proper procedures.

Quality Assurance training **must** be provided for at least one person in the sawmill, who would work along with sales and assist the head sawyer and sawmill manager in achieving maximum value and keep sales informed about log quality changes that could affect current or future sales revenue.

### **4.3 Maintenance of Equipment.**

Maintenance of equipment is very important because of the potential to impact productivity and quality, and hence the profitability and competitiveness of the wood processing operations. Maintenance schedules **must** be of a preventative nature conforming to timeframe and procedures outlined by the manufacturers in equipment manuals.

Areas for routine checks and maintenance in addition to those detailed by the manufacturers of equipment are:

- Steel cables, slings and chains, and ropes used in lifting
- Greasing of machines and rails to facilitate easier movement
- Foundation of saws to minimize vibration during use
- Strength and position of processing tables/carriages
- Cooling fluids for saws
- Sharpening and setting of blades and knives.

#### **4.3.1 Saw-doctoring (filing)**

Saw doctoring is the most important activity in primary wood processing to achieve added value of wood raw material in accordance with market demand. Saw doctoring on saw blades, knives (band saw, circular saw, molder knife, planner knife, rotary blade, and wood-slice knife) deserves serious attention because the saw doctoring process can have significant effect on finished products of the processed wood.

The saw doctor(s) needs to be well trained and very competent to be able to perform this function to affect the expected result. The Saw Doctor **must** complete a recognized saw doctor course so as to gather the necessary knowledge/competence to be able to effectively perform the operations of saw doctoring.

In addition to the competency of personnel, the appropriate equipment and other supporting infrastructure are critical for this operation. Some of the areas that can promote good saw doctoring practices are:

- Cleanliness, tidiness, air circulation, and illumination of saw doctoring room.
- Proper maintenance and storage can prevent the band saw from twisting, stretching, elongating, becoming rusty and dirty,
- Band saw blades **must** be stored in dry and clean place,
- Avoid twisting the band saw and store like a belt or ribbon and its center part is weighted with a weighing load,
- Saw **should** be hung with a support of its base; hung band saws **must** not be touching one another,
- The surface of saws before being stored can be lubricated with oil or grease.



**Figure 21: Storage of blades**

- Before storing knives, lubricate them with grease or oil, covered with oily paper or other thin paper; the knives are to be stored neatly on the shelf not in contact with each other;
- Avoid the storing of knives in places contaminated with dust and other dirt in order to prevent knives from becoming rusty.



**The proper way of storing cutter blocks ; circular saws; and molder knives**

**Figure 22: Storage of knives**



#### 4.4 Calibration of Measuring Instruments and Equipment

The systematic structure of the measurement system of wood processing operations provides important feedback to the operator and management to make changes/adjustments to the process to ensure that product requirements and importantly, market/customer requirements are met.

The instruments/equipment used in making these measurement need to be accurate, so that the data/value that is received can be used to effect decisions that will result in a quality product meeting the requirements of the expected market.

It is therefore important that instruments used to conduct measurement be calibrated to determine their accuracy, and the necessary adjustments made when inaccuracies are found. Measuring instruments associated with wood processing operations are:

- Set gauges on equipment (sawmill, planer, edger, saw filing machines, etc.)
- Tape measures
- Calipers
- Moisture meters
- Humidity meter

Calibration of measuring instruments and equipment **must** be done, and by a competent person or authority, to a schedule outlined by the manufacturer or based on usage.



Figure 23: Measuring tools for wood processing operations

## 5.0 OTHER NON-SAWMILLING ACTIVITIES THAT MUST BE ADHERED TO IN A PROCESSING OPERATION:

### 5.1 General.

Probably the greatest waste of value, grade and volume is generated at this stage of the process, as any efforts or investment to produce a quality product is totally negated by poor storage and handling of the lumber.



**Figure 24: Proper and improper storage of lumber**

The moisture content of lumber in storage **must** be controlled as moisture changes in wood are by far the greatest contributors to degrade. The lumber **must** be allowed to release moisture evenly across the width, length and thickness to minimize the potential for degrade. If lumber dries in an uneven way, it will become uneven due to warp, and lose grade.

Drying lumber enhances the properties of the wood and thereby makes the lumber more valuable. Advantages of dried lumber over undried or partially dried lumber are as follows:

- Lumber with less than 20% maximum moisture content (MC) has less risk of developing stain, decay, or mold as a result of fungal activity.
- Dried lumber is more than twice as strong and nearly twice as stiff as wet lumber.
- Fasteners driven into dry lumber, including nails and screws, will perform much better than do fasteners in wet lumber, especially if the wet lumber dries after fastening.
- Dried lumber weighs less than wet, undried lumber.
- Products made from properly dried lumber will shrink very little or none at all while in service; products made from wet lumber often shrink substantially as the wood dries.
- Quality products from gluing, machining, and finishing are much easier to accomplish with dry wood.

## 5.2 Stacking/Racking

All lumber **must** be sealed at each end with a vapor resistant sealant to prevent it drying out from the ends and stacked under cover, as quickly as possible, within 24 hrs after coming off the saw.

These stacks **must** be stored under some form of protection from rain, on a clean (free of obstacles to air flow and vegetation that harbors fungus and bacteria), well drained area on blocks off the ground to allow a free flow of air around the pile. Blocks **should** be 12 (304.8mm) – 24 inches (609.6mm) apart and stickers **should** be aligned with the blocks and with the rows above in the lumber piles to prevent distortion of the lumber. The softer the wood and thinner the pieces, the smaller the gaps between the stickers.

Stickers **must** be accurately sawn or preferably planed at least  $\frac{3}{4}$  x  $\frac{3}{4}$  inches (19.05mm x 19.05mm) or wider to allow free flow of air – there may be some advantages with fast drying softwoods to use thicker stickers to speed the air drying process.

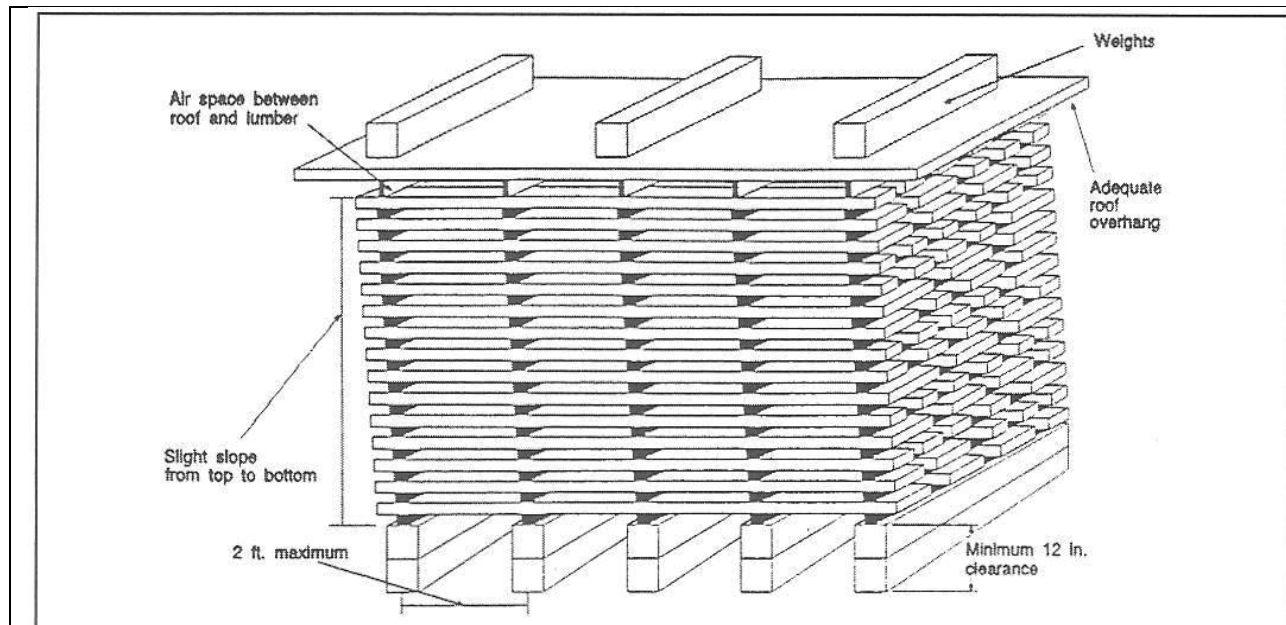

*Lumber properly stacked for air drying.*

*Top view of tier of boards, illustrating the system of alternating short lengths for box piling. Unsupported ends of boards placed on the inside will dry with less effect than if allowed to extend over the end of the pile.*

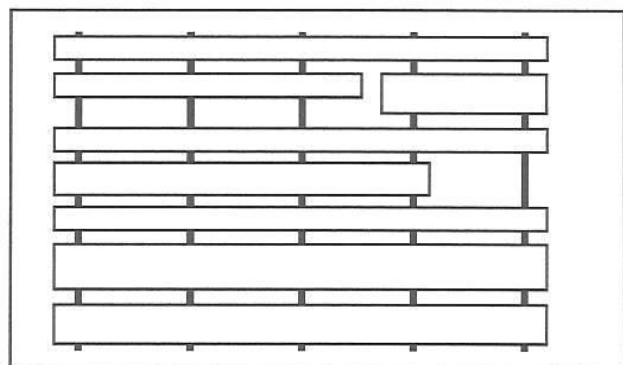

**Figure 25: Stacking and Stickering of lumber**

The ends of each board **must** be stickered within 2 inches from the ends of the boards to prevent droop and uneven drying. Uneven lengths need to be supported at the ends within the pile as well. Stickers **should** be placed 12 (304.8mm) – 24 inches (609.6mm) apart in line with blocks depending on the size and species of lumber.

For mixed lengths in the same stack, short length boards **must** be stacked together and additional stickers put in place to properly support each piece as outlined above. The lumber stacks **should** be restricted to a width of 1,800 mm. as wider stacks may lead to uneven/insufficient air flow and inconsistent drying across the stack. Stacks **should** be oriented relative to wind direction to facilitate the free flow of air through and around the stack, and easy movement and handling.

Installation of a stacking/sticker station at the end of the green chain to stack and sticker lumber in preparation for drying ensures that the heaviest volume of lumber produced in a direct production line is handled quickly rather than taking this material to another processing station

Lumber can be stacked in bundles with no stickers only if it is to be delivered or used within one week of sawing. For longer storage, all lumber **must** be stored on stickers in stacks under cover in a well ventilated and clean area.

The storage area **must** have a hard surface, be well drained, stable and free from sawdust and any other wooden debris. Each stack of lumber **must** be labeled with the date of stacking so as to allow for adequate drying time. Rough sawn wood **must** remain stickered and stacked until it has achieved a moisture content of 30% or less.

Only lumber that has been dried to a moisture content of 30% or less should be stored in racks or without stickers and all lumber **must** be segregated by grade, dimension and species/density when placed in racks.

For solid packed lumber (packed in tight bundles with no stickers) protection from rain is critical as solid piled lumber cannot loose moisture as easily as lumber that is stickered. In addition, moisture levels may increase to levels that actively promote the growth of stain or fungus.

## **5.3 Methods for Drying Lumber**

### **5.3.1 Air-dry Lumber**

This is a method of drying lumber by exposing it to natural atmospheric conditions. As such there is no control over drying rate as this will be determined by the prevailing weather (temperature, relative humidity, rainfall and wind speed), which can vary considerably from day to day. Some control over drying times and degrade can be achieved by correct stacking procedures of freshly sawn timber.

Degrade in sensitive species can be reduced by some procedures, such as placing the lumber pile under a large roof and covering the pile with open-weave plastic cloth. Moreover, air drying can provide the desired quality characteristics and is the most economical method for some products, such as upholstery frame stock. However air drying will take some time to remove moisture depending on the time dedicated and the size of the lumber, hence air drying is often seen as the first step to kiln drying.



### **Shed**

Air drying lumber under a roof protects the lumber from rain and sun, reducing the amount of degradates. Drying times are very close to those in open yard air drying; in rainy weather, lumber in sheds may dry faster and to lower MC than lumber dried in an open yard.

Sheds also offer the opportunity to restrict air flow when drying conditions are too harsh, by using burlap or plastic mesh curtains on the outside opening of the shed. The cloth can be hung so that it can be opened or closed as dictated by the drying conditions.

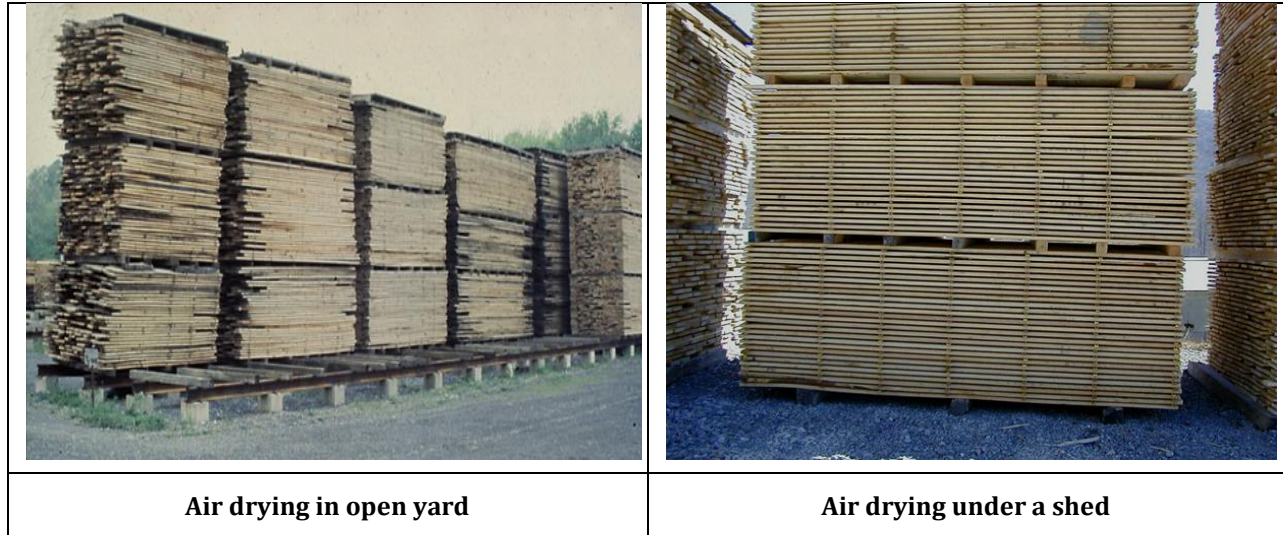

**Figure 26: Air drying lumber in open yard and under a shed**

### **Forced-Air Shed**

Some species can be dried quickly through the addition of fans to quicken the drying of lumber in air drying sheds. This can be an effective method of improving the rate and quality of drying. The additional cost for operating the fans is offset by the benefit of faster drying, which often produces clear and flatter lumber than lumber dried by other air drying methods. Thus, the forced-air drying shed is an attractive method of drying from the green condition to around 20% MC.

### **5.3.2 Kiln-dry Lumber**

Kilns are closed chambers in which air temperature, relative humidity and airflow can be controlled to dry lumber to specified moisture content. There are many different types of kilns such as vacuum systems, traditional heat and vent type kilns and radio frequency dryers.

Kiln drying is a prerequisite for the production of added value timber products, as without adequate kiln drying, quality products cannot be assured.

### **5.3.3 Solar Drying**

Solar drying offers an alternative to air drying and kiln drying and is currently being used on a commercial scale. It offers an opportunity for more control with less cost when compared with expensive kiln drying when low moisture contents are required

## 5.4 Grading of Lumber

All lumber for local sale and export **must** be graded in accordance with the ***Guyana Timber Grading Rules for Hardwood***. It is important to note that while each piece of lumber for export **must** be graded, lumber for local sales can be graded either as a piece for dimensional lumber to be used in construction or in a batch to be used for further processing.

The graded wood products **must** be properly labeled and stacked according to grade, dimension, and density/species.

## 5.5 Treating and Preserving Lumber - Preventative Treatment

The following species **must** be chemically treated, by spraying or dipping, as soon as they are converted to rough sawn lumber to prevent attack from fungi and insects.

<b>Simarupa</b> – <i>Quassia simarouba</i>	<b>Haiariballi</b> – <i>Alexa imperatricis, A. leiopetala</i>
<b>Kereti</b> – <i>Ocotea spp.</i>	<b>Dukali</b> – <i>Parahancornia fasciculata</i>
<b>Ulu</b> – <i>Trattinickia rhoifolia, T. demerarae</i>	<b>Suya</b> – <i>Pouteria speciosa</i>
<b>Baromalli</b> – <i>Catostemma spp.</i>	<b>Kurokai</b> – <i>Protium decandrum</i>
<b>Futui</b> – <i>Jacaranda copaia</i>	<b>Muneridan</b> – <i>Ruizterania albiflora, Qualea rosea</i>
<b>Iteballi</b> – <i>Vochysia spp.</i>	<b>Wadara</b> – <i>Couratarispp</i>
<b>Maho</b> – <i>Sterculia rugosa, S. pruriens</i>	<b>Swamp Dalli</b> – <i>Virola surnamensis</i>

**Note:** The above list is not exhaustive and only represents examples or a sample.

Fungicides and insecticides to be used in preventative treatment of lumber **must** be approved by the Pesticides and Toxic Chemicals Control Board.

## 5.6 Dressing Lumber/Finishing Planer - Specifications for Dressed Lumber

Finish planing generally means a final, more precise pass through a planer. Usually this results in a higher quality surface appearance and a standard finished thickness. The ends of all dressed lumber **must** be waxed or sealed with an appropriate sealant so as to prevent splitting and end checking from occurring

All rough sawn lumber to be dressed **must** be dried to a moisture content of 30% or less before dressing is carried out. The following rough sawn lumber thickness sizes are the specified cutting sizes for lumber to be further processed i.e. dressed two sides. All industry stakeholders **must** adhere to the standard thickness sizes and tolerances specified in the table 3 below.

**Table 3: Specified Thicknesses and Tolerances for Rough Sawn and Dressed Lumber**

Rough Sawn Lumber		Dressed Lumber		Tolerances	
Metric(mm)	Inches	Metric (mm)	Inches	Metric (mm)	Inches
9.53	$\frac{3}{8}$	4.76	$\frac{3}{16}$	Nil	Nil
12.7	$\frac{1}{2}$	7.94	$\frac{5}{16}$	Nil	Nil
5/8"	$\frac{5}{8}$	11.11	$\frac{7}{16}$	Nil	Nil

19.05	$\frac{3}{4}$	14.29	$\frac{9}{16}$	Nil	Nil
25.4	1	19.05	$\frac{3}{4}$	Nil	Nil
31.75	$1\frac{1}{4}$	26.99	$1\frac{1}{16}$	Nil	Nil
38.1	$1\frac{1}{2}$	33.34	$1\frac{5}{16}$	Nil	Nil
44.45	$1\frac{3}{4}$	38.1	$1\frac{1}{2}$	Nil	Nil
50.8	2	44.45	$1\frac{3}{4}$	Nil	Nil
63.5	$2\frac{1}{2}$	57.15	$2\frac{1}{4}$	Nil	Nil
76.2	3	69.85	$2\frac{3}{4}$	+/- 1.59	+/- $\frac{1}{16}$
88.9	$3\frac{1}{2}$	82.55	$3\frac{1}{4}$	+/- 1.59	+/- $\frac{1}{16}$
101.6 and over	4 and over	95.25 and over	$3\frac{3}{4}$ and over	+/- 1.59	+/- $\frac{1}{16}$

Widths will be categorized in intervals of 25.4 mm (equivalents of full inches) for rough sawn lumber with no negative tolerance and a maximum positive tolerance of 6.35 mm ( $\frac{1}{4}$ " ). Dressed lumber will also be categorized in intervals of 25.4 mm and is 6.35 mm ( $\frac{1}{4}$ " ) narrower than the corresponding nominal rough sawn equivalent. For example a rough sawn piece of 101.6 mm (4") width will yield a piece of dressed lumber measuring 95.25 mm ( $3\frac{3}{4}$ " ) in width.

Lengths of dressed lumber, unless specified differently in a contract, **must** increase in intervals of 304.8 mm (12") with a maximum oversize of 6.35 mm ( $\frac{1}{4}$ " ).

## **6.0 SOCIAL REQUIREMENTS**

### **6.1 National Insurance Scheme**

Employers **must** comply with the National Insurance and Social Security Act and associated regulations. The National Insurance Scheme extends protection and social insurance coverage to all persons between the ages of 16 and 60 years who are engaged in insurable employment and is done on a compulsory basis for all employed.

### **6.2 Labour Acts**

Employers are advised, in accordance with the Employment of Young Persons and Children Act Cap 99:01, that only person over the age of sixteen (16) years **must** be hired for any type of work within the industry



## **7.0 HEALTH AND SAFETY REQUIREMENTS**

### **7.1 General**

This Code sets out guidelines to prevent injury to persons engaged in the operation of plant and systems of work found in sawmill, lumberyards and log yards. Management **should** recognize that high yields and high profits are negated if serious injury occurs due to unsafe practices or ignored safety hazards.

The Occupational Safety and Health Act classifies both sawmills and lumberyards as industrial establishments. While it is essential that employers provide, as far as practicable, a safe and secure working environment, this document will posit specific criteria which these establishments **must** be compliant with.

The occupational health and safety (OSH) requirements outlined herein are in accordance with the aforementioned Act which stipulates that there must be a joint workplace safety and health committee, consisting of both management and employees for lumberyards and sawmills with more than 20 employees or a workplace safety and health representative appointed for less than 20 employees.

Every person at the place of work, whether as an employer, an employee, a self-employed person or a person in control of the workplace, **must** comply with the Occupational Health and Safety Act. While the obligation for each person is different, all persons **must** ensure that the way they carry out their work does not interfere with the health and safety of other persons who are present at the place of work.

- *Employers* have an obligation to ensure the health, safety and welfare of employees and other persons at the place of work and to comply with the OHS Act and Regulations. This includes the provision or maintenance of adequate amenities at work.
- *Employees* have an obligation to take reasonable care for the health and safety of other persons in the workplace and to cooperate with their employer in the interests of health, safety and welfare.
- *Any person* who has, to any extent, control of a workplace, the means of access or egress or plant or substances used has an obligation to ensure the health and safety regarding the place of work, the means of access or egress and plant or substances used at the place of work.

The employer, employees and their representatives **should** consult with each other to determine safe systems of work based on the assessment of the risk and determining the provision of safeguards.

**Note:** Employers **must** provide all the requisite occupational health and safety requirements for temporary employees as would otherwise be available to their permanent employees.

### **7.2 Personal Protective Equipment (PPE)**

Before commencing operation, employers or persons in control **must** assess conditions likely to affect the health and safety of the employees or themselves, as identified during the risk assessment procedure, and arrange for the provision and use of appropriate Personal Protective Equipment (PPE). All PPE **must** be regularly inspected and replaced as necessary.

The following PPE **must** be provided and used where necessary:

- a) Safety helmets complying with relevant standard.
- b) Hearing protection complying with relevant standard.
- c) Eye protection complying with relevant standard.
- d) Safety clothing such as safety boots, waterproof clothing, gloves, and reflective safety vest. All clothing **should** be comfortable and suitable for the work and the weather conditions. Loose clothing which may snag or create a hazard **should** be avoided and long hair should be contained. Where employees are exposed to inclement weather they **should** be issued with protective clothing.
- e) Respiratory protective equipment complying with relevant standard.

### 7.3 Safeguards on Equipment

Safeguards on equipment are necessary to prevent accidents in the workplace; hence in a wood processing operation, the employer/management **must** ensure that:

- Machine guarding **must** be done at point of operation for circular saws, plain band saws, gang saws and other cutting devices as well as for gears, belts, chains, sprockets and nip points on conveyor belts and rollers,
- Guards **must** be maintained in an efficient state and always kept in position while the machinery is in motion,
- Guard rails are places on walkways adjacent to operations or crossing over conveyors and production lines,
- Every hoist, lift, winch **must** be of good mechanical construction sound material and adequate strength and is thoroughly examined by a competent engineer at least every six months or at an earlier date, if required,
- A record is to be kept of the date(s) on which examinations and maintenance was done on particular machines, devices and other equipment. The record **must** be signed and dated by the engineer,
- Every saw is installed on a well constructed base to reduce vibration,
- No person is to be stationed at any wood working machine unless he has been adequately trained to work that machine, and
- Employees between the ages of sixteen (16) and eighteen (18) **must** always be supervised – irrespective of their training – when operating any class of machinery.

If any protective device is removed from a particular machine, a temporary protective device **must** be substituted and/or notice of the removal **must** be given to all workers who seek to use the machine.

### 7.4 Appropriate Signs Displayed

Signage **must** be in accordance with international standards and be well known to, and easily understood by workers, visitors, and the general public as appropriate.

It is the responsibility of the employer/management to ensure that the following signs are in easily visible places where required and is respected and observed at all times:

- “No Smoking”
- “High Voltage”

- “Fire Hazard”
- “Restricted Areas”
- The maximum working load which the machine can carry safely must be conspicuously marked on every hoist, lift or winch,
- Any other sign deemed applicable to the specific circumstance

Hazardous areas (electrical rooms, compressor rooms, etc), installations, materials, safety measures, and emergency exits, etc. **must** be marked appropriately.

All vessels that may contain substances that are hazardous as a result of chemical or toxicological properties, or temperature or pressure, **must** be labeled as to the contents and hazard, or appropriately color coded.

## 7.5 Training and Competency of Personnel

Employers **must** provide training and instruction, including information and supervision to ensure the health and safety of their employees at work. All persons involved in sawmilling **must** be trained to follow systems of work and work practices that enable them to perform their work in a manner that is safe and without risks to health. Only those persons who have received training and instruction **should** carry out the work.

The employer **should** monitor the systems of work and provide refresher training to ensure that safe systems and work practices are being followed, including the use of PPE. The training provided and the instruction given **must** include:

- a) the work method to be used for sawmilling operations including manual handling and control measures based on the risk assessment to prevent injury.
- b) the correct use, care and storage in accordance with the manufacturer’s recommendations of PPE, tools and equipment.
- c) the use of plant and associated equipment including electrical safety and hazardous substances, and
- d) procedures to be adopted in the event of accident, injury or other emergency.

## 7.6 Fire Protection

There are many fuel sources including flammable lubricants and solvents used in a sawmill for maintenance and clean-up. This practice of employees smoking while working could result in a devastating and potentially life threatening fire resulting in temporary or even permanent facility closure.

Employers or persons in control **must** undertake a risk assessment to identify fire hazards. Suitable control measures **must** be implemented. Evacuation procedures and fire protection equipment and procedures **must** be established.

Poor housekeeping not only presents potential tripping hazards and other operational inefficiencies, but is directly related to increasing the damages caused by a fire.

## 7.7 Community and Work Place Relations

### Lavatories and Showers

Adequate lavatory facilities (toilets and washing areas) **must** be provided for the number of people expected to work in the facility and allowances made for segregated facilities, or for indicating whether the toilet facility is “In Use” or “Vacant”. Toilet facilities **must** also be provided with adequate supplies of running water, soap, and hand drying devices.

Where workers may be exposed to substances poisonous by ingestion and skin contamination, facilities for showering and changing into and out of street and work clothes **must** be provided.

### Potable Water Supply

Adequate supplies of potable drinking water **must** be available.

Water supplied to areas of food preparation or for the purpose of personal hygiene (washing or bathing) **must** meet drinking water quality standards

### Clean Eating Area

Where there is potential for exposure to substances poisonous by ingestion, suitable arrangements are to be made for provision of clean eating areas where workers are not exposed to the hazardous or noxious substances

### Lighting

Workplaces **must**, to the degree feasible, receive natural light and be supplemented with sufficient artificial illumination to promote workers’ safety and health, and enable safe equipment operation. Supplemental ‘task lighting’ may be required where specific visual acuity requirements **must** be met.

Emergency lighting of adequate intensity **must** be installed and automatically activated upon failure of the principal artificial light source to ensure safe shut-down, evacuation, etc.

### Safe Access

Passageways for pedestrians and vehicles within and outside buildings **must** be segregated and provide for easy, safe, and appropriate access

Equipment and installations requiring servicing, inspection, and/or cleaning **should** have unobstructed, unrestricted, and ready access

Hand, knee and foot railings **should** be installed on stairs, fixed ladders, platforms, permanent and interim floor openings, loading bays, ramps, etc.

- Openings **should** be sealed by gates or removable chains
- Covers **should**, if feasible, be installed to protect against falling items
- Measures to prevent unauthorized access to dangerous areas **should** be in place

### **First Aid**

The employer **must** ensure that qualified first-aid can be provided at all times.

- Appropriately equipped first-aid stations **should** be easily accessible throughout the place of work
- Eye-wash stations and/or emergency showers **should** be provided close to all workstations where immediate flushing with water is the recommended first-aid response

### **Air Supply**

Sufficient fresh air **must** be supplied for indoor and confined work spaces. Factors to be considered in ventilation design include physical activity, substances in use, and process related emissions. Air distribution systems **should** be designed so as not to expose workers to draughts

Mechanical ventilation systems **should** be maintained in good working order. Point-source exhaust systems required for maintaining a safe ambient environment **should** have local indicators of correct functioning.

### **Work Environment Temperature**

The temperature in work, rest room and other welfare facilities **should**, during service hours, be maintained at a level appropriate for the purpose of the facility.

## **8.0 ENVIRONMENTAL REQUIREMENTS**

### **8.1 General**

The Environmental Protection Act, # 11 of 1996 and supporting regulation, mandates the EPA as the Principal Custodian of the environment and of any activities likely to affect it. The following are procedural requirements that are applicable to operators in the wood processing industry:

- *Authorizations for New Developments* – all potential applicants **must** to apply to the EPA for environmental authorization. The process involves application with the provision of supporting documentation, screening, publication of the EPA’s decision, whether or not an Environmental Impact Assessment (EIA) is required, and finally the decision to grant environmental authorization.
- *Authorizing Existing Developments* – existing establishments **must** register their activities with the EPA after which the Agency conducts audits or site inspections which are aimed at developing individual compliance schedules.

Sawmill and lumberyard owners/operators **must** be aware of this Code and its content as part of their commitment to good management and complying with environmental legislation and permit conditions.

The owner is ultimately responsible for environmental performance of the premises. He/she **must** ensure that all persons who may be responsible for the operation of the premises are familiar with the content of this Code and any permit conditions and manage the operation accordingly. The owner **must** obtain prior written approval from the approval authority before:

- changing the processes used at the premises,
- constructing or removing any structure associated with the premises,
- increasing the quantity of materials dealt with at the premises from that specified in the permit, or
- changing the nature of materials dealt with at the premises, in any manner that might cause or substantially increase the emission of a pollutant or noise from the premises.

When any accident, breakdown or malfunction of equipment may or does result in the unplanned emission of a pollutant or noise from the premises, the operator **must IMMEDIATELY** take all practicable action to contain the emission(s) and minimize adverse environmental impacts, and report the incident to the appropriate authority..

### **8.2 Solid Waste Management**

All operations will improve waste management by adopting in order of preference the following options:

- waste minimization - practices which prevent or reduce the generation of waste;
- waste reuse and recycling - direct reuse of the same material or the incorporation of that waste into other processes;
- waste treatment to reduce the hazard or nuisance - preferably at the site of generation; and
- waste disposal.

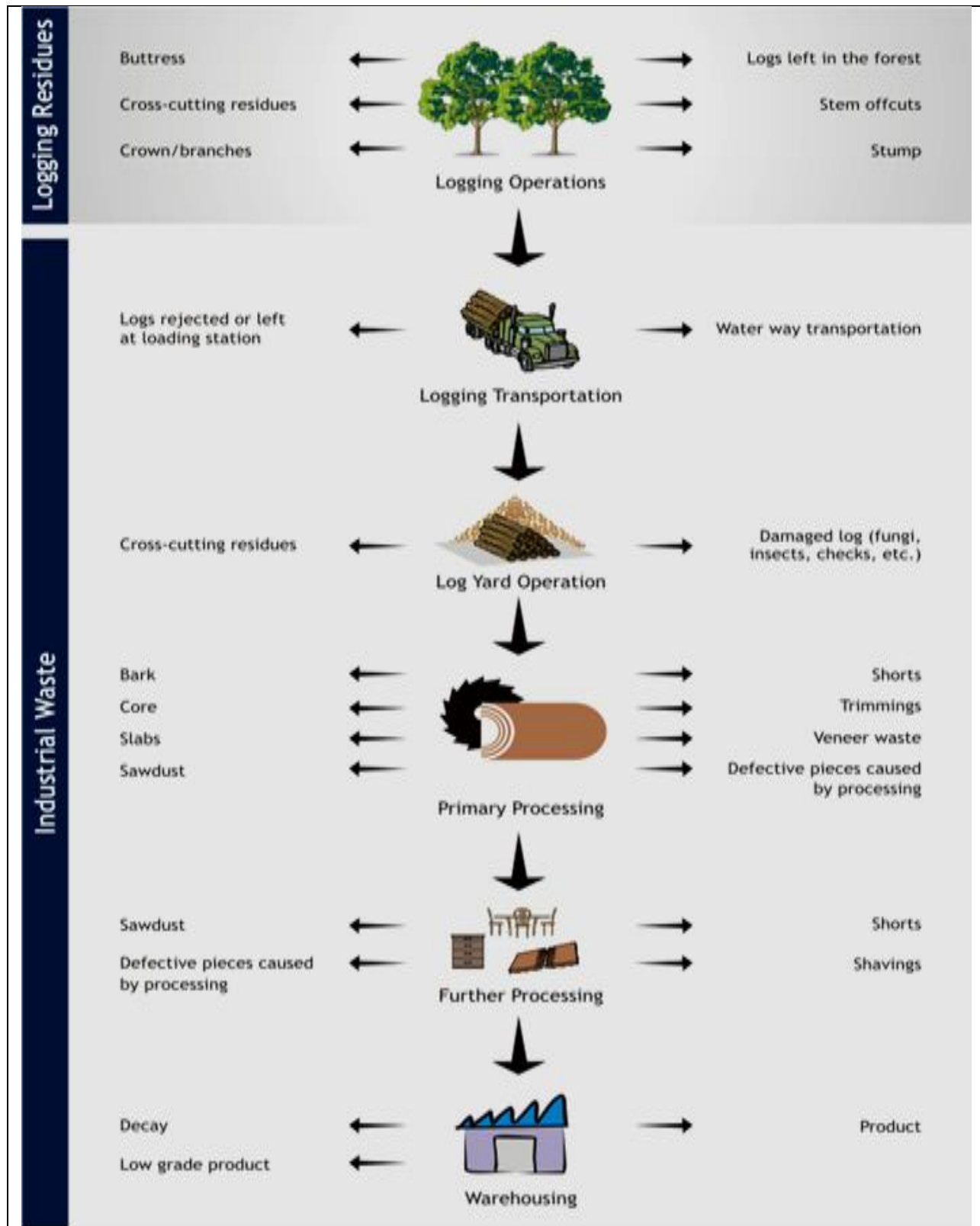

Figure 27: Waste generated from forestry value chain

### **8.2.1 Conversion Efficiency**

Solid waste generation is directly related to the conversion efficiency of round wood to sawn lumber or other final products; hence the use of modern equipment and trained staff will enhance the ability of wood processing operations to maximize its conversion efficiency.

Some technical and operational measures to increase wood conversion efficiency and minimize wood waste include:

- Optimizing primary log breakdown technology and techniques, e.g. consideration of bandsaw or framesaw use, and use of cross cut before rip cut to increase usable wood volume;
- Use of finger-jointing in downstream operations to combine scrap or low value wood into products. Use of large dimension waste products in glued laminated boards (glulam);
- Operator training and monitoring to ensure awareness and implementation of measures to improve conversion.

### **8.2.2 Recycling and Disposal**

Opportunities for recycling of wood waste may exist through use of waste as inputs for secondary products in other industries or as a source of fuel for heat and power generation. The value and disposal options for sawmill waste are usually enhanced if the waste is bark-free. Wood waste utilization and disposal options include:

- Use of sawdust and wood shavings for animal bedding;
- Use of wood waste as fuel to generate heat/power;
- Production of fuel briquettes;
- Manufacture of charcoal.

If all other feasible, beneficial uses have been considered, wood waste **should** be disposed of through controlled incineration. Accumulation of waste in a dump or landfill at the sawmill is not acceptable as these options present a serious fire hazard, which once started can be very difficult to control, in addition to having the potential for ground water contamination.

Accumulation of sawmill residues, disused equipment, waste oil and general rubbish **must** be avoided in order to minimize the potential for site contamination, reduce the visual impact of the operation and improve site safety. Refuse, including used plant and machinery parts, and domestic refuse, **must** not be buried on the premises but removed to an approved refuse disposal site.

## **8.3 Emissions to Air.**

Clean air is a workplace and surrounding community expectation hence, dust emissions and products of incomplete combustion need to be minimized to reduce the potential for degrading air quality. Dust emissions which constitute an environmental nuisance **must** not cross the boundary of the premises.

Air emissions from sawmill operations are generated from a number of sources.



- Combustion products emitted by boilers may include carbon monoxide (CO), nitrogen oxides (NO<sub>x</sub>), sulfur oxides (SO<sub>x</sub>) particulate matter (PM), and volatile organic compounds (VOCs) from bark and wood depending upon fuel selection,
- VOCs may also be emitted during kiln drying of wood and application of solvents, coatings, and lacquers,
- Wood dust and larger particulates generated during sawing, machining and sanding operations.

Extraction systems **should** be provided for locations at which these particulates are formed, including saws, sanding, shaping, and routing machines. Cyclones or bag filters are typically employed to remove particulates from the air stream before release. Good housekeeping practices **should** also be employed to minimize dust generation.

Roads within the boundary of the premises **should** be watered or sealed to minimize environmental nuisance and an effective cover to control spillage **should** be placed over all loads of wood chips and sawdust being removed from the premises.

A boiler or furnace utilizing wood residues **should** only be operated if the exhaust gases are treated using efficient particulate removal equipment agreed to by the approving authority or, alternatively it can be demonstrated that efficient combustion is being achieved. There **should** be no open burning on the premises.

#### **8.4 Waste-water/Effluent Discharge**

Waste water discharged to the environment can adversely affect the receiving water quality hence any discharge **must** be managed to avoid degrading the receiving water quality.

Wastewater effluent from sawmills is generated from runoff from irrigated storage areas known as log yards and log ponds. Wastewater is also generated from chemical coating of wood. Process wastewater containing chemical preservatives **must** be contained as part of a closed loop application system.

Recommendations to prevent, minimize and control effluents from stored timber include:

- Containment of runoff from log yards through use of impervious surfaces, sealed joints, and spill containment curbs to prevent leaching of contaminated waters into the soil and groundwater;
- Lining of log ponds to prevent contaminants leaching into the soil and groundwater;
- Recycling of irrigation water to limit effluent releases to ground and surface waters;
- Storm water from process areas **should** be segregated from storm water in non-process areas.

#### **8.5 Noise/Vibration**

Noise is the most common cause of complaint. Noise is best reduced by controls at the source of the noise. Source controls can include measures such as enclosures, mufflers, silencers, barriers and restricting the time of operation.

Noise management provisions and noise level measurements **must** be carried out by the employer or person in control to ensure compliance with applicable regulations and the recommended practices for noise management and protection.

Where the noise level is in excess of the noise exposure limits, engineering control measures **must** be implemented. Where this cannot be achieved, appropriate hearing protection equipment **must** be provided to all persons in the vicinity of the operations.

Noise reduction options that **should** be considered include:

- Selecting equipment with lower sound power levels
- Installing silencers for fans
- Installing suitable mufflers on engine exhausts and compressor components
- Installing acoustic enclosures for equipment radiating noise
- Improving the acoustic performance of constructed buildings, apply sound insulation
- Installing vibration isolation for mechanical equipment
- Limiting the hours of operation for specific pieces of equipment or operations, especially mobile sources operating through community areas
- Re-locating noise sources to less sensitive areas to take advantage of distance and shielding
- Siting permanent facilities away from community areas if possible
- Taking advantage of the natural topography as a noise buffer during facility design
- Developing a mechanism to record and respond to complaints

Reasonable hours of operation are generally considered to be between 07:00 hours and 18:00 hours weekdays and between 08:00 hours and 17:00 hours on Saturdays. Extended operating hours from those specified on a permit may be approved following submission of supporting noise monitoring reports and /or consultation with affected neighbors.

Operators **should** seek to reduce the noise impact from chainsaws as far as practicable by minimizing the time chainsaws are required to be used and avoiding the use of chainsaws during sensitive periods of the day.

Machinery and equipment **must** be well maintained to minimize noise emissions. Fans, blowers, compressors, generators and exhausts **must** be fitted with silencers. All bends in the dust extraction system ducting **should** be 'easy' bends; sharp or right angle bends **should** not be used.

Timber processing machines, (e.g. planers) have the potential to emit excessive noise and **must** be housed in acoustic enclosures. Alternatively they could be grouped in an area with appropriate soundproofing. All machines with a tendency to produce vibrations **should** be mounted on vibration dampeners and mounted on individual foundations free of the rest of the floor.

Trucks approaching and leaving the premises **should** be routed to avoid residential areas wherever practicable. In areas with residents in close proximity it may be necessary to restrict truck movements to within reasonable operating hours and along specified routes.

## 8.6 Toxic and Hazardous Chemicals

Hazardous substances released to the environment can cause significant short and long term environmental damage. To reduce the risk of release to the environment, all hazardous substances **must** be appropriately stored and handled according Material Safety Data Sheets (MSDS).

Fuel, lubricants, chemicals, coolant, waste oil and waste chemicals **must** be stored in an approved manner (such as in drums or surface tanks located on an impervious bounded area). Machinery maintenance operations **should** be undertaken in such a manner so as to capture any fluids released for reuse or appropriate disposal.

The potential harm that may result from toxic and hazardous chemicals includes:

- contamination of water courses due to run-off from the site,
- contamination of groundwater due to leakage from underground storage tanks or
- vertical migration from surface spill areas.

Human health may also be at risk where hazardous chemicals have been spilled.

## 8.7 Visual Management

Good housekeeping is strongly encouraged as a neat and tidy site reduces the visual impact of the premises, is less likely to give rise to public complaint, and will be safer.

- Lights used to illuminate any areas of the site for security or any other reason **should** be angled or shaded in such a manner so that the light does not directly illuminate any nearby residential premises.
- Effective landscaping with features such as fences, trees, shrubs, rock walls and gardens can be incorporated to screen the premises and provide an effective wind break to assist in dust control.
- Neatly stacked timber racks can also assist in establishing an effective visual screen.

## 8.8 Site Selection

Site selection is very important to businesses now and into the future. Careful site selection will reduce the potential for problems and relocation costs in the future. The location, siting and design of new developments or changes to existing operations **should** be in accordance with this Code and relevant legislation, and operate without conflict with the adjacent uses.

Some factors to consider in the selection of a suitable location for a sawmill **should** include;

- minimizing the potential for future problems from noise and atmospheric emissions.
- having sufficient land to act as a buffer for routine emissions.
- consideration of noise emissions associated with movements, loading, and unloading of trucks.

**Sawmill operators are strongly encouraged to have regular discussions with the local land planning authority so as to be aware of any proposed zoning changes which may impact on their operations.**

## **9.0 GLOSSARY OF TERMS and ACRONYMS.**

<b>Board Foot</b>	A unit of timber measurement equivalent in volume to a piece having nominal dimensions of one foot (length) by twelve inches (width) one inch (thickness). This unit is abbreviated to FBM (feet board measure) or simply BM.
<b>Bow</b>	The distortion of lumber in which there is a deviation, in a direction perpendicular to the flat face, from a straight line from end-to-end of the piece.
<b>Boxed Heart</b>	The term used when the pith falls entirely within the four faces of a piece of wood anywhere in its length. Also called boxed pith.
<b>Cant</b>	A log that has been slabbed on one or more sides. Ordinarily, cants are intended for resawing at right angles to their widest sawn face.
<b>Check</b>	A lengthwise separation of the wood that usually extends across the rings of annual growth and commonly results from stresses set up in wood during seasoning.
<b>Conditioning</b> (pre and post)	The exposure of a material to the influence of a prescribed atmosphere for a stipulated period of time or until a stipulated relation is reached between material and atmosphere.
<b>Crook</b>	The distortion of lumber in which there is a deviation, in a direction perpendicular to the edge, from a straight line from end-to-end of the piece.
<b>Cubic foot</b>	The volume of timber equivalent to a cube with sides measuring 1 foot in length, and is equal to 12 board feet or 0.028 m <sup>3</sup>
<b>Cubic metre</b>	The volume of timber equivalent to a cube with sides measuring 1 metre in length. The standard of timber measurement under the metric system. Equals 424 FBM
<b>Cup, cupping</b>	Curvature in a piece of timber across the grain after sawing. Usually caused by drying stresses. Cup is measured as the greatest deviation from a straight line across the width of the piece, expressed in millimeters or as fractions of the width
<b>Degrade</b>	Occurs through poor storage, transport or handling when additional defects are developed in timber which would not have been permitted during initial grading
<b>Density</b>	As usually applied to wood of normal cellular form, density is the mass per unit volume of wood substance enclosed within the boundary surfaces of a wood-plus-voids complex. It is variously expressed as pounds per cubic foot, kilograms per cubic meter, or grams per cubic centimetre at a specified moisture content.
<b>Dressed timber</b>	Timber, which has been planed to remove the marks of sawing on one or more faces. It is also called surfaced timber. Often abbreviated S1S (surfaced one side) up to S4S (surfaced 4 sides) and D1S (dressed one side), D1S1E (dressed one side and one edge), etc. up to DAR (dressed all round)
<b>Feed Rate</b>	The distance that the stock being processed moves during a given interval of time or operational cycle.
<b>Flitch</b>	A portion of a log sawn on two or more faces—commonly on opposite faces leaving two waney edges. When intended for resawing into lumber, it is resawn parallel to its original wide faces. Or, it may be sliced or sawn into veneer, in which case the resulting sheets of

	veneer laid together in the sequence of cutting are called a flitch.
<b>Grade</b>	The designation of the quality of a manufactured piece of wood or of logs.
<b>Grain</b>	The direction, size, arrangement, appearance, or quality of the fibers in wood or lumber. To have a specific meaning the term must be qualified.
<b>Green</b>	Freshly sawed or un-dried wood. Wood that has become completely wet after immersion in water would not be considered green but may be said to be in the “green condition.”
<b>Hardness</b>	A property of wood that enables it to resist indentation.
<b>Hardwoods</b>	A term used to describe all timbers of the broad-leafed tree species. The structure of hardwood timber is different (fibres and vessels) to that of the softwoods (tracheids). The forests of Guyana consist of tropical hardwoods
<b>Heartwood</b>	The wood extending from the pith to the sapwood, the cells of which no longer participate in the life processes of the tree. Heartwood may contain phenolic compounds, gums, resins, and other materials that usually make it darker and more decay resistant than sapwood.
<b>Kiln</b>	A chamber having controlled air-flow, temperature, and relative humidity for drying lumber. The temperature is increased as drying progresses, and the relative humidity is decreased.
<b>Knot</b>	A hard place or lump, especially on a tree, at a point from which a stem or branch grows, The round, often darker cross section of such a lump as it appears on a piece of cut lumber. Also called <i>node</i>
<b>Laminate</b>	A product made by bonding together two or more layers (laminations) of material or materials.
<b>Lumber</b>	The product of the saw and planing mill for which manufacturing is limited to sawing, resawing, passing lengthwise through a standard planing machine, crosscutting to length, and matching. Lumber may be made from either softwood or hardwood.
<b>Rough Lumber</b>	Lumber that has not been dressed (surfaced) but has been sawed, edged, and trimmed.
<b>Structural Lumber</b>	Lumber that is intended for use where allowable properties are required. The grading of structural lumber is based on the strength or stiffness of the piece as related to anticipated uses.
<b>Surfaced Lumber</b>	Lumber that is dressed by running it through a planer.
<b>Moisture Content.</b>	The amount of water contained in the wood, usually expressed as a percentage of the weight of the oven dry wood. Green timber freshly sawn may contain 70 to 100% moisture, shipping dry timber 20 to 30% and air seasoned timber about 12 to 16%.
<b>Moulding</b>	A wood strip having a curved or projecting surface, used for decorative purposes.
<b>Pallet.</b>	A low wood or metal platform on which material can be stacked to facilitate mechanical handling, moving, and storage.

<b>Pith.</b>	The small, soft core occurring near the center of a tree trunk, branch, twig, or log.
<b>Preservative</b>	Any substance that, for a reasonable length of time, is effective in preventing the development and action of wood-rotting fungi, borers of various kinds, and harmful insects that deteriorate wood.
<b>Quarter sawn</b>	The opposite to flat or backsawn. Sawnwood cut so that its width is substantially parallel with the rays of the timber. Pieces are considered quarter sawn under these rules when the rays make an angle of not more than 45 degrees to the wide face; c.f. flat sawn
<b>Rip</b>	To cut lengthwise, parallel to the grain.
<b>Rough sawn or undressed lumber</b>	Sawn timber which has not been smoothed by planing to a regular dimension
<b>Sapwood</b>	The wood of pale colour near the outside of the log. Under most conditions, the sapwood is more susceptible to decay than heartwood.
<b>Saw Kerf</b>	(1) Grooves or notches made in cutting with a saw. (2) That portion of a log, timber, or other piece of wood removed by the saw in parting the material into two pieces
<b>Seasoning</b>	The process of drying wood to the point where the moisture content is sufficiently low to enable its product to be used satisfactorily in service without degrade <b>Air Dried</b> —Dried by exposure to air in a yard or shed, without artificial heat. <b>Kiln Dried</b> —Dried in a kiln with the use of artificial heat.
<b>Small log</b>	Logs with a diameter of less than 40cm at butt end.
<b>Stickers</b>	Strips or boards used to separate the layers of lumber in a pile and thus improve air circulation.
<b>Strength</b>	(1) The ability of a member to sustain stress without failure. (2) In a specific mode of test, the maximum stress sustained by a member loaded to failure.
<b>Structural Timbers</b>	Pieces of wood of relatively large size, the strength or stiffness of which is the controlling element in their selection and use. Examples of structural timbers are trestle timbers (stringers, caps, posts, sills, bracing, bridge ties, guardrails); car timbers (car framing, including upper framing, car sills); framing for building (posts, sills, girders); ship timber (ship timbers, ship decking); and cross arms for poles.
<b>Twist</b>	A distortion caused by the turning or winding of the edges of a board so that the four comers of any face are no longer in the same plane.
<b>Taper Settings</b>	The process of skewing the log on the carriage so that the saw will travel the desired path during sawing
<b>Warp.</b>	Any variation from a true or plane surface. Warp includes bow, crook, cup, and twist, or any combination thereof.

<b>Wane</b>	A rounded edge of bark along an edge or at a corner of a section of lumber
<b>Yield/ Recovery</b>	Ratio of the amount of primary product output to the amount of raw material input, expressed as a percentage.

## **10.0 LIST OF REFERENCES**

1. Australian Government Forest and Wood Products Research and Development Corporation – Sawing Regrowth and Plantation Hardwoods with Particular Reference to Growth Stresses. Part A – Project No. PN 02. 1308.
2. Denig J & Wengert G – Sawing, Edging and Trimming Hardwood Lumber. Putting Theory into Practice – National Hardwood Lumber Association 2005 – ISBN 1-892529-6. Publication No. 7238.
3. Denig J- Small Sawmill Handbook – Doing it Right and Making Money – Miller Freeman Inc. 1993 – ISBN 0-87930-286-0.
4. Hallock H., Stern A. R. & Lewis D. W – Is there a Best Sawing Method – USDA Forest Service, Forest Products Laboratory Research Paper – FPL 280, 1978.
5. Higgs J. M. – So You Want to Build a Sawmill – USDA Forest Service – Revised 2002.
6. How S.S., Sik H.S & Ahmad I. – Review on Six Types of Log Cutting Methods in Various Applications: Part 1 – Forest Research Institute of Malaysia (FRIM) – No. 45 -2007 – ISSN: 139 -258.
7. How S.S, Zaliha A. Sita & Goh C.Y – Review on Six Types of Log Cutting Methods in Various Applications – FRIM No. 48, 2009 – ISSN: 139-258.
8. Larsen T, Erickson R. W & Petersen H. D – Saw, Dry, Rip Processing: Taking the Crook Out of the Stud Game – Proceedings of the 26 the Annual Joint Meeting, Midwest Wood Seasoning Association and Wisconsin-Michigan Wood Seasoning Association. Madison, Wisconsin. May 19<sup>th</sup> 1983.
9. Lewis D.W. – The Best Opening Face System for Sweepy, Eccentric Logs. A Users Guide – USDA Forest Service, Forest Products Laboratory – General Technical Report – FPL – 49.
10. Loehnertz S. P, Cooz I. V & Guerrero J. – Sawing Hardwoods in Five Tropical Countries – USDA Forest Service, Forest Products Laboratory. Research Note – FPL –RN – 0262. Sept. 1994.
11. Maeglin R. R & Boone R. S – Evaluation of Hardwood Studs Manufactured by the Saw- Dry-Rip (SDR) Process – USDA Forest Service, Forest Products Laboratory – Research Note – FPL-0249. March 1989.
12. Malcolm F.B – A Simplified Procedure for Developing Grade Lumber from Hardwood Logs – USDA Forest Service, Forest Products Laboratory – Research Note FPL – RN – 098.



13. Psciecznik N., Brewer M., Fehr C. & Samuel J. – A Chainsaw Milling Manual. Turning Trees to Timber – HDRA, DFID FRP 2006 -
14. Simpson, William T. & Ward, James C – Log and lumber Storage – Chapter 10 – Wood Handbook – US Forest Service, Forest Products Laboratory.  
[www.usfs.fs.fed.us/documents/usda/ah188/chapter10.pdf](http://www.usfs.fs.fed.us/documents/usda/ah188/chapter10.pdf)
15. Steele P. H – Factors Determining Lumber Recovery in Sawmilling – USDA Forest Service, Forest Products Laboratory – General Technical Report – FPL 39, 1984.
16. USDA Forest Service, Forest Products Laboratory – Wood Handbook – Wood as an Engineering Material – General Technical Report - FPL GTR -113.